

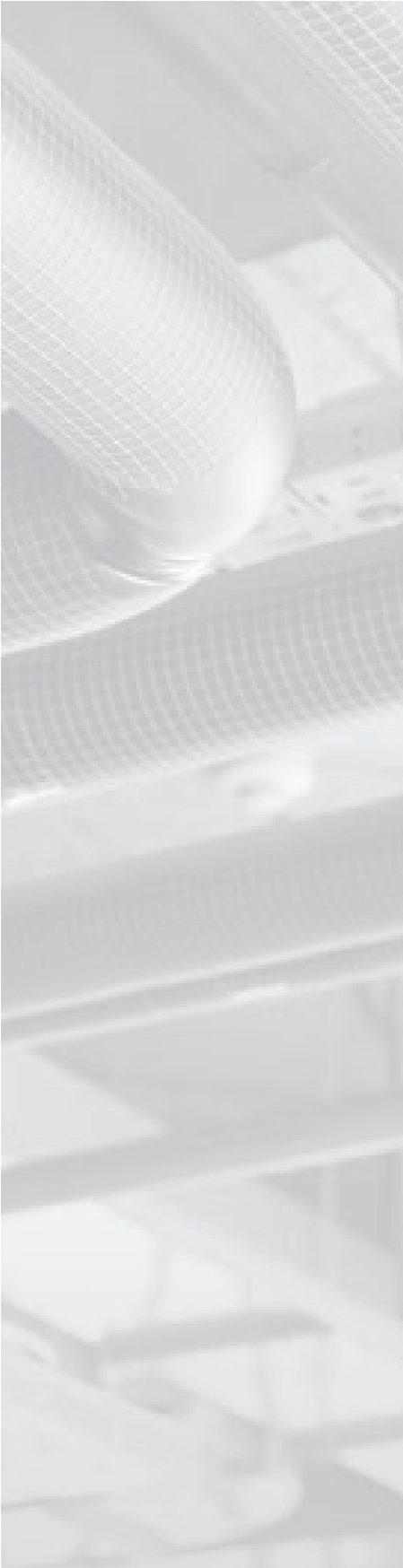





































Variable Area Flow Meters and Flow Switches



General Design Features and Benefits	Page	2
Technical Information Liquid and Gas/Flow Meter Certification	Page	3
Liquid Flow Meter Application Information/Fluid Selection Chart	Page	4
Pneumatic Flow Meter Application and Conversion Information	Page	5
Fatigue Rating Information	Page	7
Common Conversions	Page	8
EZ-View General Design Features	Page	67
Weights	Page	79

Product Locator

 <p>PETROLEUM FLUIDS Basic Flow Meters Pages 9-10</p>	 <p>WATER-BASED FLUIDS (cont) Test Kits Pages 27-30</p>	 <p>AIR/CAUSTIC & CORROSIVE GASES Basic Flow Meters Pages 39-40</p>
 <p>Test Kits Pages 11-14</p>	 <p>High Temperature Pages 31-32</p>	 <p>Flow-Alert Flow Switches Pages 45-48</p>
 <p>High Temperature Pages 15-16</p>	 <p>Flow-Alert Flow Switches Pages 45-48</p>	 <p>MR Flow Transmitters Pages 49-51</p>
 <p>Flow-Alert Flow Switches Pages 45-48</p>	 <p>MR Flow Transmitters Pages 49-51</p>	 <p>AIR & OTHER COMPRESSED GASES Basic Flow Meters Pages 41-42</p>
 <p>MR Flow Transmitters Pages 49-51</p>	 <p>WATER & OTHER LIQUIDS Basic Flow Meters Pages 33-34</p>	 <p>Test Kits Pages 43-44</p>
 <p>PHOSPHATE ESTER FLUIDS Basic Flow Meters Pages 17-18</p>	 <p>High Temperature Pages 35-36</p>	 <p>Flow-Alert Flow Switches Pages 45-48</p>
 <p>Test Kits Pages 19-22</p>	 <p>Flow-Alert Flow Switches Pages 45-48</p>	 <p>MR Flow Transmitters Pages 49-51</p>
 <p>High Temperature Pages 23-24</p>	 <p>MR Flow Transmitters Pages 49-51</p>	 <p>DIGITAL DISPLAYS Pages 59-60</p>
 <p>Flow-Alert Flow Switches Pages 45-48</p>	 <p>API OIL/CAUSTIC & CORROSIVE LIQUIDS Basic Flow Meters Pages 37-38</p>	 <p>EZ-VIEW FLOW METERS Basic ½ to 1 inch Pages 69-70</p>
 <p>MR Flow Transmitters Pages 49-51</p>	 <p>Flow-Alert Flow Switches Pages 45-48</p>	 <p>Flow-Alert ½ to 1 inch Pages 71-72</p>
 <p>WATER-BASED FLUIDS Basic Flow Meters Pages 25-26</p>	 <p>Flow Transmitters Pages 49-51</p>	 <p>Basic 1½ to 2 inch Pages 73-74</p>
		 <p>Flow-Alert 1½ to 2 inch Pages 75-76</p>
		 <p>77</p>

Mail to: Hedland Flow Meters
Badger Meter Inc.
P.O. Box 081580
Racine, WI 53408-1580 USA

Ship to: Hedland Flow Meters
Badger Meter Inc.
8635 Washington Avenue
Racine, WI 53406-3738 USA

Customers within the United States, Canada and U.S. possessions:
Call Toll-Free: 1-877-243-1010
Fax Toll-Free: 1-800-245-3569

International Customers:
Phone: 1-262-639-6770
Fax: 1-262-639-2267

Monday - Friday from 8 a.m. to 5 p.m. CST

E-mail: racorders@badgermeter.com

Web site: www.badgermeter.com

General Design Features

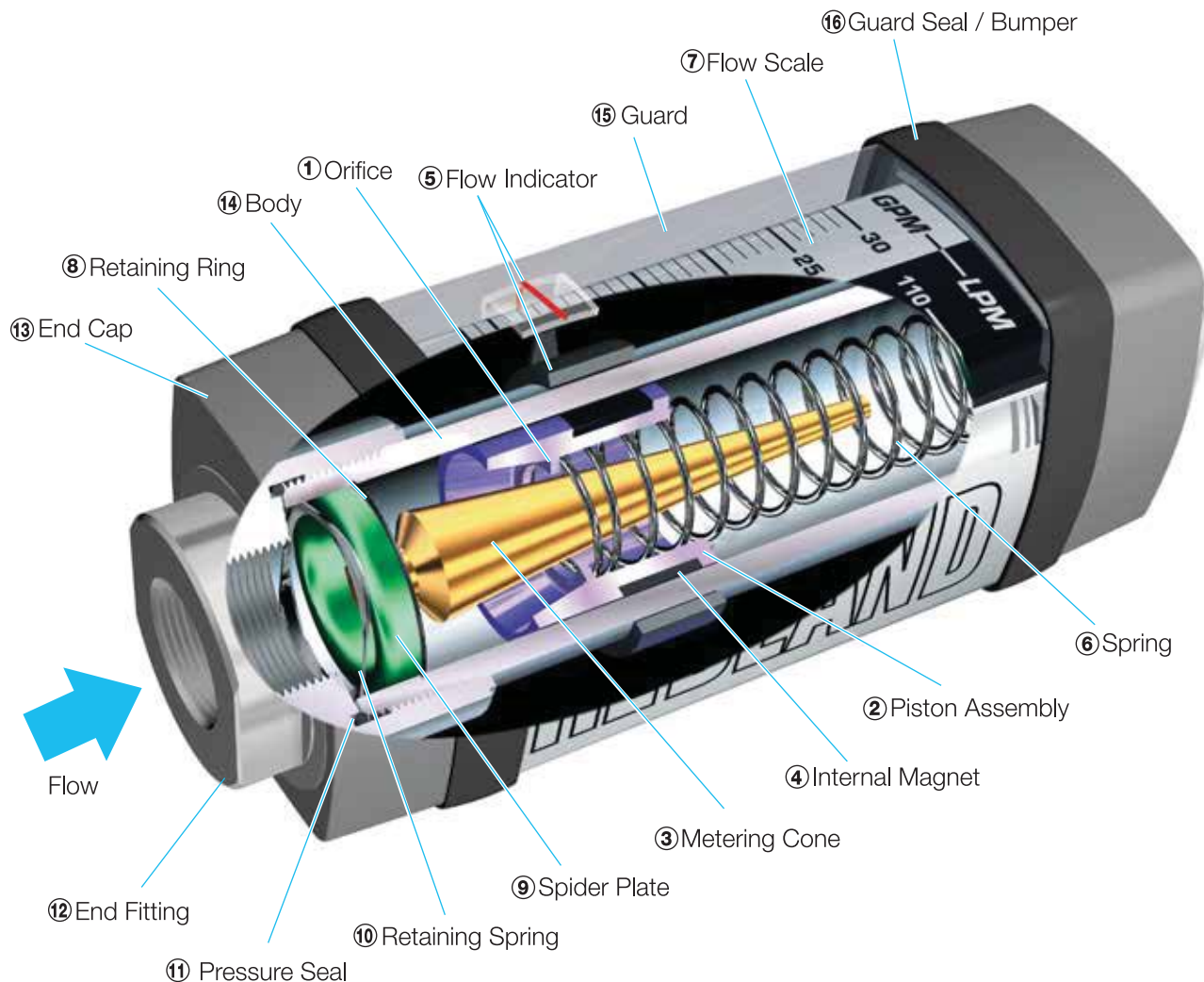

OPERATING PRINCIPLE

The Hedland flow meter is a variable area instrument. A precision machined, sharp-edged Orifice ① located within the Piston Assembly ②, forms an annular opening with the contoured Metering Cone ③. The Piston Assembly carries a cylindrical PPS/Ceramic Magnet ④ that is magnetically coupled to an external Flow Indicator ⑤ that moves precisely, in direct response to movement of the Piston. A calibrated Spring ⑥ opposes flow in the forward direction. This spring decreases viscosity sensitivity and allows the flow meter to be used in any position, including inverted.

Bi-directional flow capability: If required, a reverse flow by-pass option is available and is depicted on individual product pages. Note that flow is measured in the forward direction only.

Operates in any position: The Hedland in-line flow meter's unique spring-loaded variable area design allows meters to be installed in any position without affecting accuracy. An optional inverted flow scale is also available.

Easier to read linear scale: This flow meter is the most readable product in its class. Brightly colored indicators move over the graduated, linear Flow Scale ⑦ which contains bold, easy-to-read numerals and gauge marks. This enhanced resolution virtually eliminates parallax problems associated with competitive, direct reading flow meters.

360° Rotatable guard/scale: Hedland's unique design allows the meter to be installed in any orientation without regard to scale direction. Once the meter is permanently installed, the guard/scale can be rotated 360° to optimize readability.

Rugged construction: Flow meters are available in anodized aluminum, brass, T303 and T316 stainless steel, with SAE, NPTF, BSPP, and Code 61 and Code 62 4-bolt flanged ports. This easy-to-read flow meter is a reliable and trouble-free flow rate indicator, monitoring a variety of liquids and gases (including aggressive chemicals), under a wide range of pressures, temperatures and rigorous conditions encountered in industrial applications.

No flow straighteners or special piping: The Hedland design does not require special plumbing or accessories to stabilize turbulent flow. Flow meters can be installed immediately adjacent to 90-degree elbows or other components to provide greatest system design flexibility, while saving installation time and money.

Relatively insensitive to shock and vibration: This unique design is inherently less sensitive to shock and vibration than other variable area flow meters. The new, improved coupling forces between the internal and external magnets greatly reduce the chance of decoupling the flow indicator under high flow and pressure transients. The magnetic coupling also eliminates the need for mechanical linkages that wear, loosen and leak over the functional life of competitive meters.

Technical Information

Liquid & Gas Flow Meters

REPEATABILITY WITHIN $\pm 1\%$:

Flow meter repeatability is within $\pm 1\%$. This is particularly important in cyclical applications, which require consistent readings.

OPERATING TEMPERATURE:

Standard operating temperature range is -20 to $+240$ °F (-29 to $+116$ °C). High Temperature flow meter range is -20 to $+400$ °F (-29 to $+204$ °C) continuous, and $+400$ to $+500$ °F ($+204$ to $+260$ °C) intermittent. Maximum operating pressure of aluminum and brass body flow meters is reduced for temperatures over 240 °F (116 °C). Stainless steel flow meters do not require derating. Refer to pressure derating charts in the High Temperature flow meter section.

OPERATING PRESSURE:

Liquids: Maximum operating pressure of aluminum and brass flow meters is 3,500 psi (241 bar) in $\frac{1}{4}$ to $1\frac{1}{2}$ inch sizes and 800 psi (55 bar) for 3 inch meters. Type 303 and 316 stainless steel flow meters have a 6,000 psi (414 bar) maximum operating pressure in $\frac{1}{4}$ and $\frac{1}{2}$ inch models and 5,000 psi (345 bar) maximum operating pressure in $\frac{3}{4}$ to $1\frac{1}{2}$ inch models. All liquid flow meters are designed with a 3:1 safety factor. High temperature affects maximum operating pressure. Refer to pressure derating charts in the High Temperature flow meter section.

Air/Gases: Maximum operating pressure of aluminum and brass flow meters is 1,000 psi (69 bar) in $\frac{1}{4}$ to $1\frac{1}{2}$ inch sizes and 250 psi (17 bar) for 3 inch meters. Type 303 and 316 stainless steel flow meters have a 1,500 psi (103 bar) maximum operating pressure. All air/gas flow meters are designed with a 10:1 safety factor. All pneumatic test kits are limited to a maximum operating pressure of 600 psi (41 bar) by the control valve pressure rating. Consult factory for high pressure use.

Fatigue Rating: per NFPA T2.6.1R1-1991 - C/90 (see page 7 for further details).

PRESSURE DROP (ΔP):

Refer to pages 61 to 66 for Flow vs. Pressure Drop data for oil, phosphate ester, water-based fluids, water, and air.

FILTRATION:

Although Hedland flow meters are more contamination tolerant than most fluid system components, 200 mesh (74 micron) or better filtration is required to ensure reliable performance.

CALIBRATION:

Oil, PE and WBF flow meters are calibrated with 0.876 specific gravity, 140 SUS (32cSt) hydraulic oil, irrespective of final fluid use. After calibration, PE and WBF flow meters are computer corrected for 1.18 s.g. and 1.0 s.g. respectively. Water meters are calibrated with water at 1.0 specific gravity. Air and gas meters are calibrated with air at 1.0 specific gravity (70 °F at 100 psi).



FLOW METER CERTIFICATION

There are three (3) types of certificates available with the Hedland Flow Meter:

1. Certificate of Conformance
2. Calibration Certificate
3. Certified Drawing

Certificate of Conformance: This document states that the specified Hedland Flow Meter meets the performance standards indicated in the Hedland Catalog. The certificate is signed by the Corporate Quality Assurance Manager or authorized delegate and should meet most needs for performance certification.

Calibration Certificate: This document contains the actual flow vs. indicated flow of a specific flow meter. It documents the error of each flow point relative to the stated tolerance limit. The master meters used to calibrate flow meters are traceable to the National Institute for Standards and Testing (NIST).

Meter Type Traceable Range

Petroleum-based	0.02 to 400 GPM/0.08 to 1514 LPM
Water-based	0.02 to 325 GPM/0.08 to 1230 LPM
Air/gas	0.5 to 1000 SCFM/0.24 to 472 LPS

Certified Drawings: Certified assembly prints are available and contain:

1. Final meter assembly with part number and dimensions
2. Parts list by part number and description
3. Authorized drawing signatures

Reproducible ANSI A-D size drawings are available on standard bond paper. Large size drawings can also be reduced to ANSI A or B sizes. ACAD R13 and 2000 drawings can be sent by electronic format when requested.

Certificate of Origin and Flow Meter Tags also available upon request.

Liquid Flow Meter

Application Information

STANDARD FLOW SCALES:

Standard liquid flow scales are calibrated in gpm and lpm at 0.876 specific gravity for petroleum-based fluids, 1.18 s.g. for phosphate ester based fluids and 1.0 s.g. for water and water-based fluids. For field conversion of the standard scale to other fluids, see liquid propane example below.

SPECIAL FLOW SCALES:

Special scales are available for liquids and gases in any measurement unit, and other fluid viscosities and/or specific gravities.

VISCOSITY EFFECT (SUS/cSt):

Hedland's design utilizes a precision machined, sharp-edged orifice and biasing calibration spring that ensures operating stability and accuracy over the wide viscosity range common to many fluids. Generally, high flow models of each meter size provide good accuracy over a viscosity range of 40 to 500 SUS (4.2 to 108 cSt).

DENSITY EFFECT (specific gravity):

Any fluid density change from stated standards has a proportional effect on meter accuracy. Special scales can be supplied if actual specific gravity decreases accuracy beyond application limits.

Corrections for more or less dense fluids can be made to standard scales using the following correction factor:

$$\sqrt{1.0 / \text{specific gravity, for water/water-based meters}}$$

$$\sqrt{0.876 / \text{specific gravity, for petroleum-based meters}}$$

Example: Measuring liquid propane with petroleum meter

Fluid ~ Liquid Propane (LPG)

Scale Measured Flow ~ 28.5 gpm

1. Select (LPG) specific gravity from the Fluid Selection Chart = 0.51
2. Since petroleum meter is utilized, select petroleum formula
3. Divide 0.876 by 0.51 = 1.72
4. Take square root of 1.72 = 1.31 (correction factor)
5. Multiply scale reading by 1.31, 28.5 (indicated flow) × 1.31 (correction factor) = 37.3 gpm (actual flow of liquid propane)

This correction may be ignored for petroleum-based hydraulic fluids.



Fluid Selection Chart

Fluid	Specific Gravity	Correction Factor of Standard Scale		Internal Body Material			External Press. Seals		Dust Guard			
		Oil	Water	Aluminum	Brass	T316 SST	T303 SST	Vitron®	EPR	Polycarbonate	Nylon	Pyrex®
Acetic Acid (Air Free)	1.06	0.909	0.971	C	N	R	R	R	R	C	N	R
Acetone	0.79	1.053	1.125	R	R	R	R	N	R	N	R	R
Alcohol Butyl (Butanol)	0.83	1.027	1.098	C	C	R	R	C	R	R	R	R
Alcohol Ethyl (Ethanol)	0.83	1.027	1.098	C	C	R	R	C	R	R	N	R
Ammonia	0.89	0.992	1.060	R	C	R	R	N	R	N	C	R
Benzene	0.69	1.127	1.204	C	R	R	C	R	N	N	R	R
Carbon Disulphide	1.26	0.834	0.891	R	N	R	R	R	N	N	R	R
Castor Oil	0.97	0.950	1.015	C	R	R	C	R	N	C	C	R
Cotton Seed Oil	0.93	0.970	1.037	C	R	R	R	R	N	R	R	R
Ethylene Glycol 50/50	1.12	0.884	0.945	R	R	R	R	R	R	R	C	R
Freon II	1.46	0.774	0.828	R	R	R	R	R	N	R	R	R
Gasoline	0.70	1.119	1.195	R	R	R	R	R	N	C	R	R
Glycerin	1.26	0.834	0.891	R	R	R	R	R	R	R	C	R
Kerosene	0.82	1.033	1.104	R	R	R	R	R	N	R	R	R
Liquid Propane (LPG)	0.51	1.310	1.400	R	R	R	R	R	N	N	R	R
Mineral Oil	0.92	0.976	1.042	R	N	R	R	R	N	R	R	R
Naphtha	0.76	1.074	1.147	R	N	R	R	R	N	C	R	R
Perchloroethylene	1.62	0.735	0.786	C	N	R	R	R	N	N	N	R
Petroleum Oil	0.876	1.000	1.068	R	R	R	R	R	N	R	R	R
Phosphate Ester	1.18	0.862	0.921	R	R	R	R	N	R	N	R	R
Phosphate Ester Base	1.26	0.833	0.891	R	R	R	R	N	R	N	R	R
Phosphoric Acid (Air Free)	1.78	0.701	0.749	N	N	R	N	R	N	R	N	R
Sea Water	1.03	0.922	0.985	N	N	C	C	N	R	R	R	R
Synthetic Petroleum Base	1.00	0.936	1.000	R	C	R	R	R	N	R	R	R
Water	1.00	0.936	1.000	N	R	R	R	N	R	R	R	R
Water Glycol 50/50	1.07	0.905	0.967	R	R	R	R	R	N	R	R	R
Water-in-oil	0.93	0.970	1.037	R	R	R	R	N	R	R	R	R

Pyrex is a registered trademark of Corning, Inc.
Vitron is a registered trademark of DuPont Dow Elastomers

R - Recommended N - Not Recommended C - Consult Factory

Pneumatic Flow Meter

Application Information

SELECTING A HEDLAND PNEUMATIC FLOW METER

Flow meters are offered in Aluminum, Brass, T303 and T316 Stainless Steel. This wide alloy selection allows for applications from relatively benign dry compressed air to corrosive gases such as hydrogen chloride or sulfur dioxide.

Aluminum, Brass and Type 303 Stainless Steel are available in four configurations: Standard inlet and outlet ports, an extended inlet cap fitted with a pressure gauge, an extended inlet cap with a ¼ inch NPTF plugged gauge port, and a test kit with an extended inlet cap fitted with a 160 psi pressure gauge and control valve on the outlet.

Consult the factory for the configuration best suited to your application.

STANDARD FLOW RATE SCALES – AIR/GASES

The Hedland Pneumatic Flow Meter is offered with a standard Multi-Pressure Flow Scale.

The **Multi-Pressure Flow Scale** (Figure 1) has a vertically graduated scale, calibrated for air in standard cubic feet per minute (scfm) at 1.0 s.g. (70 °F at 100 psi), or liters per second (lps) at 1.0 s.g. (21 °C at 6.9 bar). The multi-pressure scale design allows for use at line pressures from 40 to 130 psi in 10 psi increments (3.0 to 9.0 bar in 1 bar increments). This configuration **requires** that a pressure gauge be installed at the meter inlet.

To use, the operator reads the inlet gauge pressure and selects the appropriate vertical line or interpolated value closest to the gauge reading and follows the line until it intersects the brightly colored horizontal indicator bar. The flow rate in scfm/lps is read by taking the intersection point and following the slope of the closest diagonal line to a scale value and interpolating the scfm/lps flow rate. No further calculations are required.

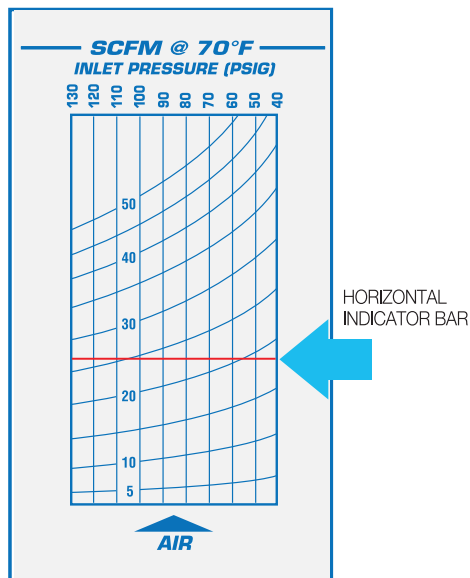

Figure 1. Multi-Pressure Flow Scale

A special **Single Pressure Flow Scale** is available in U.S. and metric units for an additional charge, see Price and Availability Digest, Form 000141. This is a graduated scale, calibrated for air in standard cubic feet per minute (scfm) at 1.0 s.g. (70 °F at 100 psi), or liters per second (lps) at 1.0 s.g. (21 °C at 6.9 bar), see Figure 2, Single Pressure Flow Scale, for further details. A standard cubic foot of air is defined as a cubic foot of air at 70 °F, at atmospheric pressure 14.7 psia at sea level. Since it is impossible to flow air at "standard" conditions the scale is calibrated for an inlet condition of 100 psi (6.9 bar) at 70 °F (21 °C). A correction factor must be calculated to determine the actual air volume. Each meter is supplied with the Conversion Chart shown in Figure 3.

Hedland can also supply a specially calibrated scale for higher or lower fixed pressures in any measurement unit, and other fluid specific gravities. Consult factory for details.

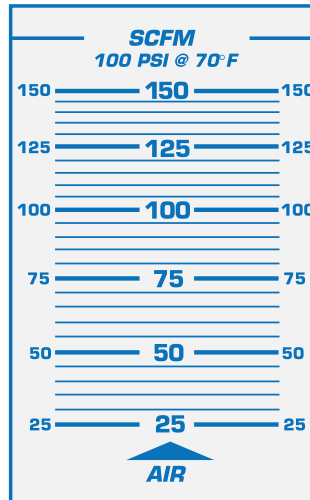
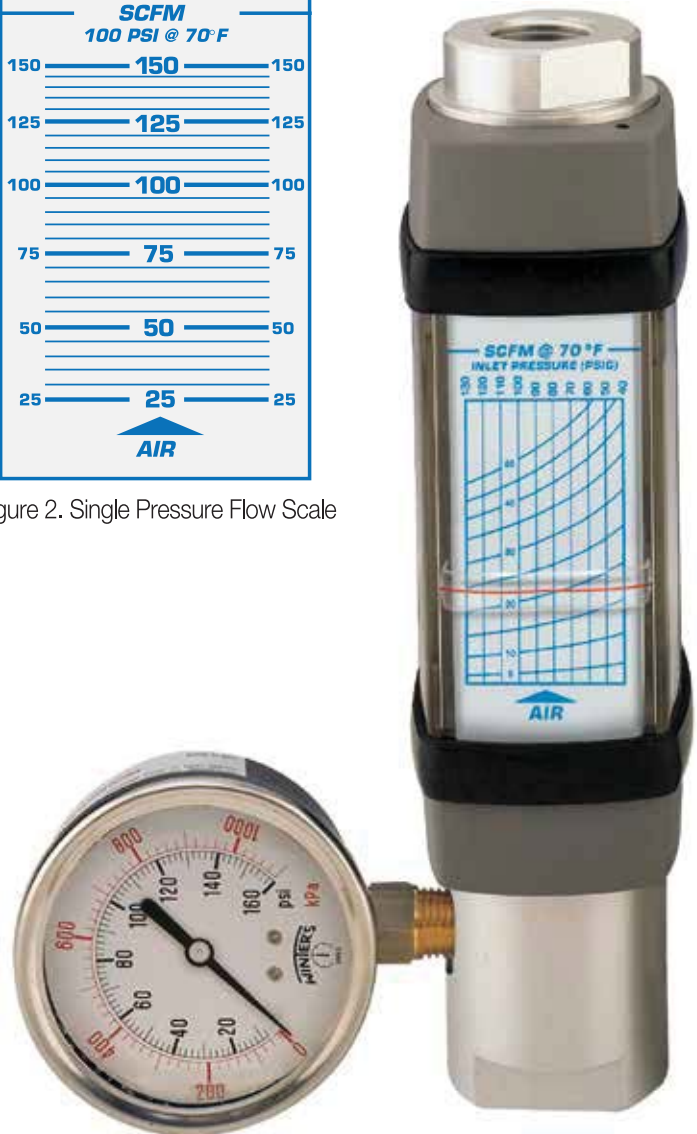

Figure 2. Single Pressure Flow Scale



Conversion Information

Chart Calculations and Flow Meter Sizing (SCFM Applications)

Compressibility of Gases

Since gases are significantly compressible, their density varies with pressure and temperature. Tables 1 & 2 of the Conversion Chart shown in Figure 3 are used to convert “indicated” scfm flow rates to “actual” scfm flow rates for your application.

Effects of Specific Gravity

Standard scales are calibrated for air with a specific gravity of 1.0. Table 3 of the Conversion Chart shown in Figure 3 is used to calculate “actual” scfm flow rates of gases with a specific gravity other than 1.0.

Example: Measuring Natural Gas with Air Meter

Operating Parameters

Fluid ~ Natural Gas
 Line Pressure ~ 140 psig
 Temperature ~ 40 °F
 Desired Maximum Flow ~ 85 scfm
 Pressure Drop ~ 10 psid maximum
 Port Size ~ ½ inch NPTF desired

1. Pressure correction for 140 psi

$$f_1 = \sqrt{\frac{114.7}{14.7 + 140}} = \sqrt{\frac{114.7}{154.7}} = .861$$

2. Temperature correction for 40° F

$$f_2 = \sqrt{\frac{460 + 40}{530}} = \sqrt{\frac{500}{530}} = .971$$

3. Specific gravity correction for natural gas, s.g. = 0.60

$$f_3 = \sqrt{.60} = .775$$

4. Make total correction calculation. f_{total}

$$f_{total} = f_1 \times f_2 \times f_3 = .861 \times .971 \times .775 = .648$$

5. To determine actual flow vs. indicated flow: read indicated flow at 100 psi vertical line on the multipressure scale (see Figure 1) and apply correction factor.

$$scfm (actual) = \frac{55 \text{ scfm (indicated)}}{.648 (f_{total})} = 84.9$$

6. 10 psid maximum

See page 66 for pressure drop (ΔP) to find the appropriate size/flow range to meet the 10 psid requirements.

7. To determine which standard Hedland meter is required to achieve desired maximum flow of 85 scfm.

$$85 \text{ scfm (max flow)} \times .648 (f_{total}) = 55.1 \text{ scfm}$$

8. From the example – model H671A-100 or H771A-100 can be selected. Both meet the 55.1 scfm flow requirement and operate with less than 10 psid. The actual scale range can be calculated as follows:

$$10 \text{ scfm (standard)} \div .648 (f_{total}) = 15.4 \text{ scfm (actual)}$$

$$100 \text{ scfm (standard)} \div .648 (f_{total}) = 154.3 \text{ scfm (actual)}$$



DETERMINE FLOW RATES USING DIFFERENT PRESSURES & TEMPERATURES										
scfm (actual) =		$\frac{\text{scfm (indicated)}}{f_1 \times f_2 \times f_3}$		Where f_1 = Conversion factor for inlet pressure f_2 = Conversion factor for temperature f_3 = Conversion factor for specific gravity						
TABLE 1 PRESSURE CORRECTION FACTOR (f_1) Operating Pressure										
psig	25	50	75	100	125	150	175	200	225	250
BAR	1.7	3.5	5.2	6.9	8.6	10.4	12.1	13.8	15.5	17.2
kPa	172	345	517	689	862	1034	1207	1379	1551	1724
f_1	1.700	1.331	1.131	1.00	.902	.835	.778	.731	.692	.658
$f_1 = \sqrt{\frac{114.7}{14.7 + \text{psig}}}$ $f_1 = \sqrt{\frac{7.914}{1.014 + \text{BAR}}}$ $f_1 = \sqrt{\frac{790.857}{101.357 + \text{kPa}}}$										
TABLE 2 TEMPERATURE CORRECTION FACTOR (f_2)										
°F	+10	+30	+50	+70	+90	+110	+130	+150	+170	+190
°C	-12.2	-1.1	+9.9	+21.0	+32.1	+43	+54	+65	+76	+88
f_2	.942	.962	.981	1.00	1.018	1.037	1.055	1.072	1.090	1.107
$f_2 = \sqrt{\frac{460 + \text{°F}}{530}}$ $f_2 = \sqrt{\frac{273 + \text{°C}}{293}}$										
TABLE 3 SPECIFIC GRAVITY CORRECTION FACTOR (f_3)										
$f_3 = \sqrt{\text{Sp. Gr.}}$										

Figure 3. Conversion Chart

Fluid Selection Chart

Fluid	Specific Gravity	Correction Factor of Standard Scale	Internal Body Material				External Press. Seals			Dust Guard	
			Aluminum	Brass	T316 SST	T303 SST	Viton®	EPR	Polycarbonate	Nylon	Pyrex®
Air	1.0	1000	R	R	R	R	R	R	R	R	R
Argon	1.38	1.175	R	R	R	R	R	R	R	R	R
Carbon Dioxide (CO ₂)	1.53	1.237	R	R	R	R	R	R	R	R	R
Freon 11 (CCl ₃ F)	4.92	2.218	R	R	R	R	R	R	R	R	R
Freon 12 (CCl ₂ F)	4.26	2.060	R	R	R	R	R	R	R	R	R
Helium (HE)	0.14	0.374	R	R	R	R	R	R	R	R	R
Hydrogen (H ₂)	0.07	0.265	R	R	R	R	R	R	R	R	R
Natural Gas	0.60	0.775	C	C	R	C	R	N	C	R	R
Nitrogen (N ₂)	0.97	0.985	C	C	R	R	R	R	C	R	R
Oxygen (O ₂)	1.10	1.049	R	R	R	R	R	R	R	R	R
Propane (C ₃ H ₈)	1.57	1.253	R	R	R	R	R	N	N	R	R

R - Recommended N - Not Recommended C - Consult Factory

Figure 4. Specific Gravity and Correction Factor for Common Gases

Conversion Information

Chart Calculations and Flow Meter Sizing (ACFM Applications)

Example:

Operating Parameters

Fluid ~ Air

Line Pressure ~ 35 psig

Temperature ~ 70 °F

Desired Maximum Flow ~ 20 acfm

Since acfm measurements are not relative to the standard 1 atmosphere condition (14.7 psia), the volume of a cubic foot at 35 psig must first be related to the volume it would occupy at 1 atmosphere. The two volumes are related through Boyle's Law.

Since, $V \propto \frac{1 \text{ Atm}}{\times \text{Atm}}$, then $V_1 P_1 = V_2 P_2$, and

$$V_1 = 20 \text{ acfm}$$

$$P_1 = 35 \text{ psig} + 14.7 \text{ psig}$$

$$V_2 = \text{scfm}$$

$$P_2 = 14.7 \text{ psia}$$

$$V_2 = \frac{V_1 P_1}{P_2} = \frac{20 \times (35 + 14.7)}{14.7} = 67.62 \text{ scfm}$$

To correct for density at 35 psig; Use Figure 3 (Tables 1, 2 & 3) on page 6.

$$f_1 = \sqrt{\frac{114.7}{14.7 + 35}} = 1.52$$

$$f_2 = 1.0$$

$$f_3 = 1.0$$

$$f_1 \times f_2 \times f_3 = 1.52 \times 1.0 \times 1.0 = 1.52 = f_{\text{total}}$$

$$V_2 \times f_{\text{total}} = \text{Hedland indicated flow}$$

$$67.62 \times 1.52 = 102.78 \text{ scfm indicated}$$

A Hedland meter installed in this system would indicate 103 scfm. Hedland can also supply a custom calibrated scale for higher or lower fixed pressures in any measurement unit, and other fluid specific gravities. Consult factory for details.



High Cycle/High Pressure Fatigue Rating:

per NFPA/T2.6.1 R1 - 1991, C/90

The method of verifying rated fatigue pressure (or establishing the rated burst pressure, or both) of the pressure containing envelope conforms to NFPA/T2.6.1 R1, Fluid power systems and products – Method for verifying the fatigue and establishing the burst pressure ratings of the pressure containing envelope of a metal fluid power component.

Meter	Aluminum		Brass		Stainless Steel	
	RFP*	Cycles	RFP*	Cycles	RFP*	Cycles
¼	2000	1 x 10 ⁶	**		3000	1 x 10 ⁶
½	2000	1 x 10 ⁶	**		3000	1 x 10 ⁶
¾	1500	1 x 10 ⁶	**		3000	1 x 10 ⁶
1	1500	1 x 10 ⁶	**		3000	1 x 10 ⁶
1¼	1000 1500	1 x 10 ⁶ 70 x 10 ³	**		3000	1 x 10 ⁶
1½	1000 1500	1 x 10 ⁶ 70 x 10 ³	**		3000	1 x 10 ⁶

* RFP = Rated Fatigue Pressure, psi

** Consult Factory

Common Conversions

To Convert	Into...	Multiply by...
Barrel (U.S. liquid)	Gallons	31.5
Bars	Kgs/sq meter	10,200
Bars	Pounds/sq in	14.50
Centigrade	Fahrenheit	(C° x 9.5) +32
Cubic centimeters	Cu feet	.00003521
Cubic centimeters	Cu inches	0.06102
Cubic centimeters	Cu meters	.000001
Cubic centimeters	Gallons (U.S. liquid)	.0002642
Cubic centimeters	Liters	0.001
Cubic feet	Cu cms	28,320
Cubic feet	Cu inches	1,728
Cubic feet	Cu meters	0.02832
Cubic feet	Gallons (U.S. liquid)	7.48052
Cubic feet	Imperial gallons	6.23210
Cubic feet	Liters	28.317
Cubic feet/min	Cu cms/min	28,317
Cubic feet/min	Gallons/min	7.481
Cubic feet/min	Liters/min	28.32
Cubic feet/sec	Gallons/min	448.83
Cubic inches	Cu cms	16.39
Cubic inches	Cu feet	.0005787
Cubic inches	Cu meters	.00001639
Cubic inches	Gallons (U.S. liquid)	.004329
Cubic inches	Imperial gallons	.0036065
Cubic inches	Liters	0.01639
Cubic meters	Cu cms	1,000,000
Cubic meters	Cu feet	35.31
Cubic meters	Cu inches	61,023
Cubic meters	Gallons (U.S. liquid)	264.2
Cubic meters	Liters	1,000
Degree Fahrenheit	Degree Celsius	t °C = (t °F - 32)/1.8
Feet/min	Cms/sec	0.5080

To Convert	Into...	Multiply by...
Feet/min	Meters/min	0.3048
Gallons/min	Cu cms/min	3,785.412
Gallons/min	Cu feet/min	.1337
Gallons/min	Liters/min	3.785
Imperial gallons	Cu feet	.160459
Imperial gallons	Cu inches	277.274
Imperial gallons	Liters	4.54374
Imperial gallons	U.S. gallons	1.20032
Kilograms/sq cm	Pounds/sq ft	2,048
Kilograms/sq cm	Pounds/sq in	14.22
Kilograms/sq meter	Bars	.00009807
Kilograms/sq meter	Pounds/sq in	.001422
Liters	Cu cm	1,000
Liters	Cu feet	0.0353145
Liters	Cu inches	61.0234
Liters	Cu meters	0.001
Liters	Gallons (U.S. liquid)	0.264170
Liters	Imperial gallons	.220083
Liters/min	Cu cms/min	1000
Liters/min	Cu feet/min	.035
Liters/min	Gallons/min	.264
Pascal (Pa)	Bar	.00001
Pascal (Pa)	Pounds/sq in	.000145
Pounds/sq inch	Kgs/sq meter	703.1
Pounds/sq inch	Pascal (Pa)	6,895
Pounds/sq inch	Bar	.069
U.S. gallons	Imperial gallons	.83267
U.S. gallons	Cu cms	3785
U.S. gallons	Cu feet	.133681
U.S. gallons	Cu inches	231
U.S. gallons	Cu meters	.3785
U.S. gallons	Liters	3.785

Viscosity Conversion Table					
	Saybolt Universal Seconds (SSU)	ISO-VG	CentiStoke	CentiPoise*	Typical Brands/Liquids at 100 °F
Standard Range	31	2	1.0	0.876	Water
	35	3	2.5	2.19	-
	40	5	4.2	3.68	-
	45	5/7	5.9	5.17	-
	50	7	7.5	6.57	Kerosene
	55	7/10	8.8	7.71	Atlantic Richfield/Duro 55 Hyd. Oil
	60	10	10.5	9.20	Monsanto/Skydrol - 500 A
	70	10/15	13.2	11.56	Mobil/Aero HFA Hydraulic Oil
	80	15	15.7	13.75	No 4 Fuel Oil
	90	22	18.2	15.94	Stauffer Chemical/Fyrquel 90
	100	22	20.6	18.05	Conoco/Syncon Synthetic AW Hyd. Oil
	150	32	32.0	28.03	Mobil/DTE 24 Hydraulic Oil
	200	46	43.2	37.84	Citco/Glycol FR-40XD (Oil in Water)
	300	68	65.0	56.94	SAE 20 Crankcase Oil
400	68/100	86.0	75.34	Sunoco/Sunvis 41 Hydraulic Oil	
Extended Range**	500	100	108	94.61	SAE 30 Crankcase Oil
	750	150	162	141.91	SAE 40 Crankcase Oil
	1000	220	216	189.22	Mobil/Paper Machine Oil - Type K
	1500	320	323	282.95	SAE 50 Crankcase Oil
	2000	460	431	377.56	Amoco/American Industrial Oil - No. 460
	3000	680	648	567.65	SAE 140 Gear Oil
	4000	1000	862	755.11	SAE 250 Gear Oil

* Centipoise are given for oil of 0.876 specific gravity. Relationship: centistokes x specific gravity = centipoise

** Meters measuring fluid within this range may require custom scales. Consult factory for details.

3500/6000 PSI Flow Meters

For Petroleum Fluids

- Direct reading
- Install in any position
- 360° rotatable guard/scale
- Easier-to-read linear scale
- No flow straighteners or special piping required
- Relatively insensitive to shock and vibration
- Good viscosity stability
- Temperature up to 240 °F
- Accuracy $\pm 2\%$ full scale
- Repeatability $\pm 1\%$
- Special scales available
- Calibrated for .876 S.G.



SPECIFICATIONS:

MATERIALS:

2024 - T351 Anodized aluminum body, piston and cone

C360 Brass body, piston and cone[Ⓛ]

T303 Stainless body, 2024 - T351 Anodized aluminum piston and cone

COMMON PARTS:

Spider Plate: T316 SS

Spring: T302 SS

Fasteners: T303 SS

Pressure Seals: Viton[®]

Guard: Polycarbonate

Retaining Ring: SAE 1070/1090 Carbon Steel

Retaining Spring: SAE 1070/1090 Carbon Steel

Indicator and Internal Magnet: PPS / Ceramic

Guard Seal / Bumper: Buna N

Scale Support: 6063 - T6 Aluminum

End Caps: Nylon ST

THREADS: SAE J1926-1*, NPTF ANSI B2.2, BSPP ISO1179, **Code 61** and **Code 62:** SAEJ518

TEMPERATURE RANGE: -20 to +240 °F (-29 to +116 °C) for higher temp. meters, see page 13

PRESSURE RATING:

Aluminum / Brass Operating: 3,500 psi/241 bar max. (800 psi/55 bar max. for 3" series) with a 3:1 safety factor.

For High Cycle Applications: See page 7

Stainless Steel Operating: 6,000 psi/414 bar max. (5,000 psi/345 bar max. for ¾" to 1½" series and 4,000 psi/276 bar max. for code 62 flange) with a 3:1 safety factor.

For High Cycle Applications: See page 7

PRESSURE DROP: See Ordering Information Table, page 10.

For detailed differential pressure charts, see page 55.

ACCURACY: $\pm 2\%$ of full scale, $\pm 7\%$ of full scale for ¼" meters **REPEATABILITY:** $\pm 1\%$

* SAE ports will accept both light-duty (SAE J1926-3) and heavy-duty (SAE J1926-2) stud ends, except 1/4 (SAE 6) size, which will accept only light-duty (SAE J1926-3) studs ends.

REVERSE FLOW BY-PASS OPTION:

Features a two-piece cone that responds to flow in the primary flow direction in the same manner as the standard design.

Flow in the reverse direction causes the lower cone shuttle to shift, moving it below the sharp-edged piston orifice. This shift creates a gap which allows the fluid to flow freely in the reverse direction.

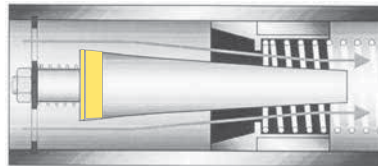

Normal Flow Direction

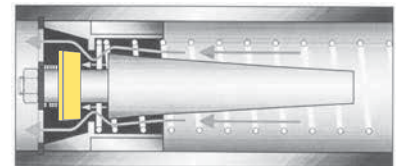

Reverse Flow By-Pass

DIMENSIONS:

A	B	C	D	E	F
NOMINAL PORT SIZE	LENGTH in (mm)	WIDTH in (mm)	DEPTH in (mm)	OFFSET in (mm)	FLATS in (mm)
¼ (SAE 6)	4.8 (122)	1.68 (43)	1.90 (48)	.84 (21)	.88 (22)
½ (SAE 10)	6.6 (168)	2.07 (53)	2.40 (61)	1.04 (26)	1.25 (32)
¾ (SAE 12)	7.2 (183)	2.48 (63)	2.85 (72)	1.24 (32)	1.50 (38)
1 (SAE 16)	7.2 (183)	2.48 (63)	2.85 (72)	1.24 (32)	1.75 (44)
1¼ (SAE 20)	12.2 (310)	4.12 (105)	4.72 (120)	2.06 (52)	2.75 (70)
1½ (SAE 24)	12.2 (310)	4.12 (105)	4.72 (120)	2.06 (52)	2.75 (70)

NOTE: Dimensions for 1½" Code 62, 3" and 3" Code 61 can be found on page 78.

Weights for all sizes can be found on page 79.

Ⓛ 3 inch models have Celcon[®] piston/piston ring

Celcon is a registered trademark of Hoechst Celanese Corp. Viton is a registered trademark of DuPont Dow Elastomers

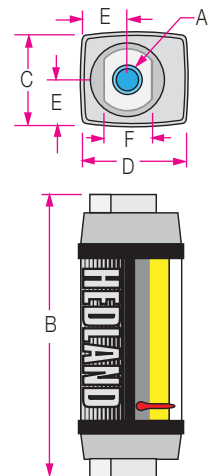

3500/6000 PSI Flow Meters

For Petroleum Fluids

ORDERING INFORMATION:

NOMINAL PORT SIZE ^②	FLOW RANGE		PRESSURE DROP			MODEL NUMBER (see example below)			MATERIAL			OPTIONS
	GPM	LPM	50% FLOW PSI (BAR)	100% FLOW PSI (BAR)	REVERSE 100% FLOW PSI (BAR)	SAE	NPTF	BSPP ^③	ALUMINUM 3500 PSI	BRASS 3500 PSI	STAINLESS	
¼" SAE 6	.02 - 0.2	0.1 - 0.75	3.5 (.24)	4.0 (.28)		H200 * - 002 - †	H201 * - 002 - †	H202 * - 002 - †	A	B	6000 PSI	Not Available
	.05 - 0.5	0.2 - 1.9	3.0 (.21)	5.0 (.35)		H200 * - 005 - †	H201 * - 005 - †	H202 * - 005 - †				
	0.1 - 1.0	0.5 - 3.75	4.0 (.28)	9.0 (.62)		H200 * - 010 - †	H201 * - 010 - †	H202 * - 010 - †				
	0.2 - 2.0	1 - 7.5	6.0 (.41)	13 (.90)		H200 * - 020 - †	H201 * - 020 - †	H202 * - 020 - †				
½" SAE 10	0.1 - 1.0	0.5 - 3.75	2.0 (.14)	2.75 (.19)	5.2 (.36)	H600 * - 001 - †	H601 * - 001 - †	H602 * - 001 - †	A	B	6000 PSI	RF
	0.2 - 2.0	1 - 7.5	2.0 (.14)	3.0 (.21)	9.6 (.66)	H600 * - 002 - †	H601 * - 002 - †	H602 * - 002 - †				
	0.5 - 5.0	2 - 19	3.0 (.21)	6.0 (.41)	4.8 (.33)	H600 * - 005 - †	H601 * - 005 - †	H602 * - 005 - †				
	1 - 10	5 - 38	4.0 (.28)	9.5 (.66)	23.0 (1.6)	H600 * - 010 - †	H601 * - 010 - †	H602 * - 010 - †				
	1 - 15	4 - 56	6.5 (.45)	18.5 (1.3)	55.2 (3.8)	H600 * - 015 - †	H601 * - 015 - †	H602 * - 015 - †				
						H600 * - 020 - †	H601 * - 020 - †	H602 * - 020 - †				
¾" SAE 12	0.2 - 2.0	1 - 7.5	1.0 (.07)	2.0 (.14)	2.9 (.20)	H700 * - 002 - †	H701 * - 002 - †	H702 * - 002 - †	A	B	5000 PSI	RF
	0.5 - 5.0	2 - 19	2.5 (.17)	3.5 (.24)	5.3 (.37)	H700 * - 005 - †	H701 * - 005 - †	H702 * - 005 - †				
	1 - 10	5 - 38	3.5 (.24)	9.0 (.62)	8.8 (.61)	H700 * - 010 - †	H701 * - 010 - †	H702 * - 010 - †				
	2 - 20	10 - 76	4.0 (.28)	9.0 (.62)	18.0 (1.24)	H700 * - 020 - †	H701 * - 020 - †	H702 * - 020 - †				
	3 - 30	10 - 115	7.0 (.48)	16.5 (1.1)	45.1 (3.11)	H700 * - 030 - †	H701 * - 030 - †	H702 * - 030 - †				
						H700 * - 040 - †	H701 * - 040 - †	H702 * - 040 - †				
1" SAE 16	0.2 - 2.0	1 - 7.5	1.0 (.07)	2.0 (.14)	2.9 (.20)	H760 * - 002 - †	H761 * - 002 - †	H762 * - 002 - †	A	B	5000 PSI	RF
	0.5 - 5.0	2 - 19	2.5 (.17)	3.5 (.24)	5.3 (.37)	H760 * - 005 - †	H761 * - 005 - †	H762 * - 005 - †				
	1 - 10	5 - 38	3.5 (.24)	9.0 (.62)	8.8 (.61)	H760 * - 010 - †	H761 * - 010 - †	H762 * - 010 - †				
	2 - 20	10 - 76	4.0 (.28)	9.0 (.62)	18.0 (1.24)	H760 * - 020 - †	H761 * - 020 - †	H762 * - 020 - †				
	3 - 30	10 - 115	7.0 (.48)	16.5 (1.1)	45.1 (3.11)	H760 * - 030 - †	H761 * - 030 - †	H762 * - 030 - †				
	4 - 40	15 - 150	9.0 (.62)	24 (1.7)	87.5 (6.04)	H760 * - 040 - †	H761 * - 040 - †	H762 * - 040 - †				
	5 - 50	20 - 190	12.5 (.86)	34 (2.3)	150 (10.4)	H760 * - 050 - †	H761 * - 050 - †	H762 * - 050 - †				
						H760 * - 060 - †	H761 * - 060 - †	H762 * - 060 - †				
1¼" SAE 20	3 - 30	10 - 110	3.0 (.21)	4.0 (.28)	4.8 (.33)	H800 * - 030 - †	H801 * - 030 - †	H802 * - 030 - †	A	B	5000 PSI	RF
	5 - 50	20 - 190	3.5 (.24)	7.0 (.48)	12.5 (.86)	H800 * - 050 - †	H801 * - 050 - †	H802 * - 050 - †				
	10 - 75	40 - 280	5.0 (.35)	10.5 (.72)	31.9 (2.2)	H800 * - 075 - †	H801 * - 075 - †	H802 * - 075 - †				
	10 - 100	50 - 380	6.5 (.45)	15 (1.0)	39.0 (2.7)	H800 * - 100 - †	H801 * - 100 - †	H802 * - 100 - †				
	10 - 150	50 - 560	10.5 (.72)	27.5 (1.9)	110 (7.6)	H800 * - 150 - †	H801 * - 150 - †	H802 * - 150 - †				
						H800 * - 200 - †	H801 * - 200 - †	H802 * - 200 - †				
1½" SAE 24	3 - 30	10 - 110	3.0 (.21)	4.0 (.28)	4.8 (.33)	H860 * - 030 - †	H861 * - 030 - †	H862 * - 030 - †	A	B	5000 PSI	RF
	5 - 50	20 - 190	3.5 (.24)	7.0 (.48)	12.5 (.86)	H860 * - 050 - †	H861 * - 050 - †	H862 * - 050 - †				
	10 - 75	40 - 280	5.0 (.35)	10.5 (.72)	31.9 (2.2)	H860 * - 075 - †	H861 * - 075 - †	H862 * - 075 - †				
	10 - 100	50 - 380	6.5 (.45)	15.0 (1.0)	39.0 (2.7)	H860 * - 100 - †	H861 * - 100 - †	H862 * - 100 - †				
	10 - 150	50 - 560	10.5 (.72)	27.5 (1.9)	110 (7.6)	H860 * - 150 - †	H861 * - 150 - †	H862 * - 150 - †				
						H860 * - 200 - †	H861 * - 200 - †	H862 * - 200 - †				
1½" Code 62	3 - 30	10 - 110	3.0 (.21)	4.0 (.28)	4.8 (.33)	H808 * - 030 - †			A	B	4000 PSI	RF
	5 - 50	20 - 190	3.5 (.24)	7.0 (.48)	12.5 (.86)	H808 * - 050 - †						
	10 - 75	40 - 280	5.0 (.35)	10.5 (.72)	31.9 (2.2)	H808 * - 075 - †						
	10 - 100	50 - 380	6.5 (.45)	15 (1.0)	39.0 (2.7)	H808 * - 100 - †						
	10 - 150	50 - 560	10.5 (.72)	27.5 (1.9)	110 (7.6)	H808 * - 150 - †						
3" Code 61	10 - 200	50 - 750	11 (.76)	17 (1.1)		Not Available	H901 * - 200	H902 * - 200	800 PS		Not Available	
	20 - 300	100 - 1100	11 (.76)	18 (1.2)			H901 * - 300	H902 * - 300	800 PS			

NOTE: RF option is not available with standard brass flow meters.

② Fractional sizes apply to NPTF and BSPP.

③ 3 inch models have BSPT (BS21) threads

(example) H 701 **A** - 030 - **RF**



3500/6000 PSI Test Kits

For Petroleum Fluids

- Direct reading
- Install in any position
- 360° rotatable guard/scale
- Easier-to-read linear scale
- No flow straighteners or special piping required
- Relatively insensitive to shock and vibration
- Good viscosity stability
- Temperature up to 240 °F
- Accuracy $\pm 2\%$ full scale
- Repeatability $\pm 1\%$
- Special scales available
- Calibrated for .876 S.G.

SPECIFICATIONS:

MATERIALS:

2024 – T351 Anodized aluminum body, piston and cone

C360 Brass body, piston and cone

T303 Stainless body, 2024 – T351 Anodized aluminum piston and cone

COMMON PARTS: Retaining Ring: SAE 1070/1090 Carbon Steel
 Spider Plate: T316 SS Retaining Spring: SAE 1070/1090 Carbon Steel
 Spring: T302 SS Indicator and Internal Magnet: PPS / Ceramic
 Fasteners: T303 SS Guard Seal / Bumper: Buna N
 Pressure Seals: Viton® Scale Support: 6063 - T6 Aluminum
 Guard: Polycarbonate End Caps: Nylon ST

THREADS: SAE J1926/1, NPTF ANSI B2.2, BSPP ISO1179

TEMPERATURE RANGE: -20 to +240 °F (-29 to +116 °C)

PRESSURE RATING:

Aluminum / Brass Operating: 3,500 psi/241 bar max. with a 3:1 safety factor.

For High Cycle Applications: See page 7

Stainless Steel Operating: 6,000 psi/414 bar max. (5,000 psi/345 bar max. for 3/4" and 1" series) with a 3:1 safety factor.

For High Cycle Applications: See page 7

PRESSURE DROP: See Ordering Information Table, page 12.

For detailed differential pressure charts, see page 55.

ACCURACY: $\pm 2\%$ of full scale

REPEATABILITY: $\pm 1\%$

PRESSURE GAUGE: Glycerin dampened, 0 - 3,500 psi / 0 - 240 bar pressure range available on aluminum and brass test kits.

Glycerin dampened, 0 - 6,000 psi / 0 - 400 bar pressure range available on stainless steel test kits.

LOAD VALVE: 1/2", 3/4" and 1" series - needle valve;

Produce ΔP up to 3,500 psi/241 bar PSID and 6,000 psi/414 bar PSID.



DIMENSIONS:

	A	B	B ₁	C	D	E	F
NOMINAL PORT SIZE	LENGTH in (mm)	LENGTH in (mm)	LENGTH in (mm)	WIDTH in (mm)	DEPTH in (mm)	OFFSET in (mm)	FLATS in (mm)
1/2 (SAE 10)	6.6 (168)	10.3 (262)	2.07 (53)	2.40 (61)	1.04 (26)	1.25 (32)	
3/4 (SAE 12)	7.2 (183)	11.3 (287)	2.48 (63)	2.85 (72)	1.24 (32)	1.50 (38)	
1 (SAE 16)	7.2 (183)	11.3 (287)	2.48 (63)	2.85 (72)	1.24 (32)	1.75 (44)	

NOTE: Weights for all sizes can be found on page 79.
 SAE and BSPP Test Kits include inlet adapter.

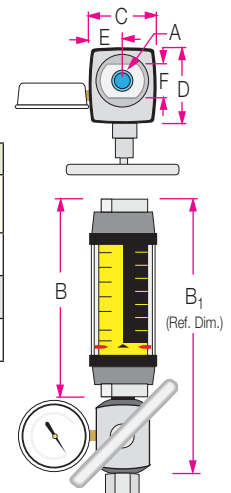

Viton is a registered trademark of DuPont Dow Elastomers

3500/6000 PSI Test Kits

For Petroleum Fluids

ORDERING INFORMATION:

NOMINAL PORT SIZE [Ⓞ]	FLOW RANGE		PRESSURE DROP			MODEL NUMBER (see example below)			MATERIAL			OPTIONS
	GPM	LPM	50% FLOW PSI (BAR)	100% FLOW PSI (BAR)	REVERSE 100% FLOW PSI (BAR)	SAE	NPTF	BSPP	ALUMINUM 3500 PSI	BRASS 3500 PSI	STAINLESS	
½" SAE 10	0.1 - 1.0	0.5 - 3.75	3.0 (.21)	4.75 (.33)	7.2 (.50)	H600 * - 001 - TK	H601 * - 001 - TK	H602 * - 001 - TK	A	B	S	6000 PSI RT
	0.2 - 2.0	1 - 7.5	5.0 (.34)	9.0 (.62)	15.6 (1.1)	H600 * - 002 - TK	H601 * - 002 - TK	H602 * - 002 - TK				
	0.5 - 5.0	2 - 19	10.0 (.69)	26.0 (1.8)	24.8 (1.7)	H600 * - 005 - TK	H601 * - 005 - TK	H602 * - 005 - TK				
	1 - 10	5 - 38	24.0 (1.7)	71.5 (4.9)	85 (5.9)	H600 * - 010 - TK	H601 * - 010 - TK	H602 * - 010 - TK				
	1 - 15	4 - 56	39.0 (2.7)	155 (10.7)	210 (14.5)	H600 * - 015 - TK	H601 * - 015 - TK	H602 * - 015 - TK				
¾" SAE 12	0.2 - 2.0	1 - 7.5	1.5 (.10)	3.0 (.21)	3.9 (.27)	H700 * - 002 - TK	H701 * - 002 - TK	H702 * - 002 - TK	A	B	S	5000 PSI RT
	0.5 - 5.0	2 - 19	4.0 (.28)	6.5 (.45)	8.3 (.57)	H700 * - 005 - TK	H701 * - 005 - TK	H702 * - 005 - TK				
	1 - 10	5 - 38	6.5 (.45)	16.0 (1.1)	15.8 (1.1)	H700 * - 010 - TK	H701 * - 010 - TK	H702 * - 010 - TK				
	2 - 20	10 - 76	11.0 (.76)	26.0 (1.8)	35.0 (2.4)	H700 * - 020 - TK	H701 * - 020 - TK	H702 * - 020 - TK				
	3 - 30	10 - 115	18.0 (1.2)	47.5 (3.3)	76.1 (5.2)	H700 * - 030 - TK	H701 * - 030 - TK	H702 * - 030 - TK				
1" SAE 16	0.2 - 2.0	1 - 7.5	1.5 (.10)	3.0 (.21)	3.9 (.27)	H760 * - 002 - TK	H761 * - 002 - TK	H762 * - 002 - TK	A	B	S	5000 PSI RT
	0.5 - 5.0	2 - 19	4.0 (.28)	6.5 (.45)	8.3 (.57)	H760 * - 005 - TK	H761 * - 005 - TK	H762 * - 005 - TK				
	1 - 10	5 - 38	6.5 (.45)	16.0 (1.1)	15.8 (1.1)	H760 * - 010 - TK	H761 * - 010 - TK	H762 * - 010 - TK				
	2 - 20	10 - 76	11.0 (.76)	26.0 (1.8)	35.0 (2.4)	H760 * - 020 - TK	H761 * - 020 - TK	H762 * - 020 - TK				
	3 - 30	10 - 115	18.0 (1.2)	47.5 (3.3)	76.1 (5.2)	H760 * - 030 - TK	H761 * - 030 - TK	H762 * - 030 - TK				
	4 - 40	15 - 150	26.0 (1.8)	75.0 (5.2)	139 (9.6)	H760 * - 040 - TK	H761 * - 040 - TK	H762 * - 040 - TK				
	5 - 50	20 - 190	63.5 (4.4)	114 (7.9)	230 (15.9)	H760 * - 050 - TK	H761 * - 050 - TK	H762 * - 050 - TK				

ⓄFractional sizes apply to NPTF and BSPP.

(example) H 701 A - 030 - RT



NOTE: TK suffix represents standard test kit configuration. For reverse flow by-pass test kit, replace TK suffix with RT suffix.

NOTE: RT option is not available with standard brass flow meters.

REVERSE FLOW BY-PASS OPTION: Features a two-piece cone that responds to flow in the primary flow direction in the same manner as the standard design. Flow in the reverse direction causes the lower cone shuttle to shift, moving it below the sharp-edged piston orifice. This shift creates a gap which allows the fluid to flow freely in the reverse direction.

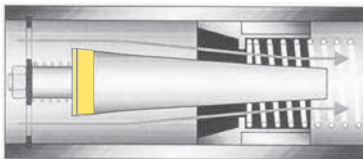

Normal Flow Direction

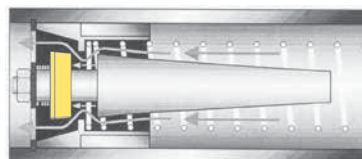

Reverse Flow By-Pass

3500/5000 PSI Test Kits

For Petroleum Fluids (1-1/4" and 1-1/2")

- Direct reading
- Install in any position
- 360° rotatable guard/scale
- Easier-to-read linear scale
- No flow straighteners or special piping required
- Relatively insensitive to shock and vibration
- Good viscosity stability
- Temperature up to 240 °F
- Accuracy $\pm 2\%$ full scale
- Repeatability $\pm 1\%$
- Special scales available
- Calibrated for .876 S.G.



SPECIFICATIONS:

MATERIALS:

2024 – T351 Anodized aluminum body, piston and cone

T303 Stainless body, 2024 – T351 Anodized aluminum piston and cone

COMMON PARTS:	Retaining Ring: SAE 1070/1090 Carbon Steel
Spider Plate: T316 SS	Retaining Spring: SAE 1070/1090 Carbon Steel
Spring: T302 SS	Indicator and Internal Magnet: PPS / Ceramic
Fasteners: T303 SS	Guard Seal / Bumper: Buna N
Pressure Seals: Viton®	Scale Support: 6063 - T6 Aluminum
Guard: Polycarbonate	End Caps: Nylon ST

THREADS: NPT

TEMPERATURE RANGE: -20 to +240 °F (-29 to +116 °C)

PRESSURE RATING:

Aluminum: 3,500 psi/241 bar max. with a 3:1 safety factor.

For High Cycle Applications: See page 7

Stainless Steel Operating: 5,000 psi/345 bar max. with a 3:1 safety factor.

For High Cycle Applications: See page 7

PRESSURE DROP: See Ordering Information Table, page 14.

For detailed differential pressure charts, see page 61.

ACCURACY: $\pm 2\%$ of full scale

REPEATABILITY: $\pm 1\%$

PRESSURE GAUGE: Glycerin dampened, 0 - 3,500 psi / 0 - 240 bar pressure range available on aluminum test kits.

Glycerin dampened, 0 - 6,000 psi / 0 - 400 bar pressure range available on stainless steel test kits.

LOAD VALVE: Produce ΔP up to 3,500 psi/241 bar PSID and 5,000 psi/345 bar PSID.

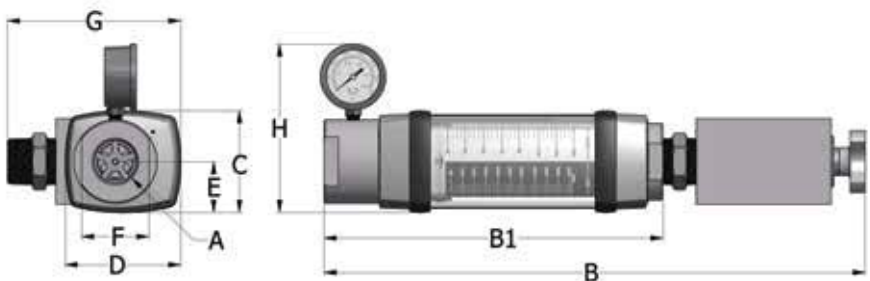

DIMENSIONS:

A	B	B ₁	C	D	E	F	G	H
NOMINAL PORT SIZE	LENGTH in (mm)	LENGTH in (mm)	WIDTH in (mm)	DEPTH in (mm)	OFFSET in (mm)	FLATS in (mm)	DEPTH in (mm)	WIDTH in (mm)
1-1/4	22.1 (561)	13.9 (353)	4.15 (105)	4.75 (121)	2.08 (53)	2.75 (70)	7.1 (180)	6.9 (175)
1-1/2	22.1 (561)	13.9 (353)	4.15 (105)	4.75 (121)	2.08 (53)	2.75 (70)	7.1 (180)	6.9 (175)

NOTE: Weights for all sizes can be found on page 79.

Pressures above 7500 PSI will pop the rupture disc allowing fluid flow to continue. This is a fail safe mechanism.

Viton is a registered trademark of DuPont Dow Elastomers

3500/5000 PSI Test Kits

For Petroleum Fluids

ORDERING INFORMATION:

NOMINAL PORT SIZE	FLOW RANGE		PRESSURE DROP			MODEL NUMBER (see example below)	MATERIAL		OPTIONS
	GPM	LPM	50% FLOW PSI (BAR)	100% FLOW PSI (BAR)	REVERSE 100% FLOW PSI (BAR)	NPT	ALUMINUM 3500 PSI	STAINLESS 5000 PSI	REVERSE FLOW
1¼"	3 - 30	10 - 110	3.4 (.23)	7.8 (.54)	5.6 (.39)	H TK 801 * - 030	A	S	RT
	5 - 50	20 - 190	4.3 (.30)	8.8 (6.1)	14.3 (.99)	H TK 801 * - 050			
	10 - 75	40 - 280	6.3 (.43)	14.3 (9.9)	35.7 (2.5)	H TK 801 * - 075			
	10 - 100	50 - 380	8.3 (.57)	21.3 (1.5)	45.3 (3.1)	H TK 801 * - 100			
	10 - 150	50 - 560	14.3 (.99)	41.3 (2.8)	124 (8.6)	H TK 801 * - 150			
1½"	3 - 30	10 - 110	3.4 (.23)	7.8 (.54)	5.6 (.39)	H TK 861 * - 030	A	S	RT
	5 - 50	20 - 190	4.3 (.30)	8.8 (6.1)	14.3 (.99)	H TK 861 * - 050			
	10 - 75	40 - 280	6.3 (.43)	14.3 (9.9)	35.7 (2.5)	H TK 861 * - 075			
	10 - 100	50 - 380	8.3 (.57)	21.3 (1.5)	45.3 (3.1)	H TK 861 * - 100			
	10 - 150	50 - 560	14.3 (.99)	41.3 (2.8)	124 (8.6)	H TK 861 * - 150			

(example) H RT 801 A - 030

NOTE: TK suffix represents standard test kit configuration. For reverse flow by-pass test kit, replace TK suffix with RT suffix.

REVERSE FLOW BY-PASS OPTION: Features a two-piece cone that responds to flow in the primary flow direction in the same manner as the standard design. Flow in the reverse direction causes the lower cone shuttle to shift, moving it below the sharp-edged piston orifice. This shift creates a gap which allows the fluid to flow freely in the reverse direction.

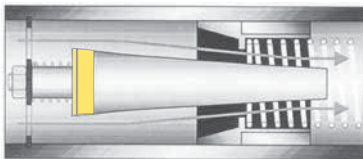

Normal Flow Direction

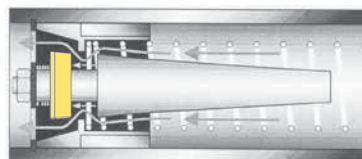

Reverse Flow By-Pass

3500/6000 PSI High Temperature

Flow Meters For Petroleum Fluids

- Direct reading
- Install in any position
- 360° rotatable guard/scale
- Easier-to-read linear scale
- No flow straighteners or special piping required
- Relatively insensitive to shock and vibration
- Good viscosity stability
- Temperature up to 500 °F
- Accuracy ±2% full scale
- Repeatability ±1%
- Special scales available
- Calibrated for .876 S.G.



SPECIFICATIONS:

MATERIALS:

2024 - T351 Anodized aluminum body, piston and cone

C360 Brass body, piston and cone

T303 Stainless body, 2024 - T351 Anodized aluminum piston and cone

COMMON PARTS:

Spider Plate: T316 SS

Spring: T302 SS

Fasteners: T303 SS

Seals: Viton®

Scale Support: T316 SS

Scale: Polyimide

Retaining Ring: SAE 1070/1090 Carbon Steel

Retaining Spring: SAE 1070/1090 Carbon Steel

Indicator: Nickel-plated Carbon Steel

Internal Magnet: Teflon® Coated Alnico 8

Bumper: 2011 - T3 Anodized Aluminum

Guard: Cylindrical Pyrex® Glass

End Caps: 2011 - T3 Anodized Aluminum

THREADS: SAE J1926/1, NPTF ANSI B2.2, BSPP ISO1179, **Code 62:** SAEJ518

TEMPERATURE RANGE: -20 to +400 °F (-29 to +205 °C) Continuous

+400 to +500 °F (+205 to +260 °C) Intermittent

For detailed "Pressure vs. Temperature" correlation information, see page 14.

PRESSURE RATING:

Aluminum / Brass Operating: 3,500 psi/241 bar max. with a 3:1 safety factor.

For High Cycle Applications: See page 7

Stainless Steel Operating: 6,000 psi/414 bar max. (5,000 psi/345 bar max.

for ¾" to 1½" series) with a 3:1 safety factor.

For High Cycle Applications: See page 7

PRESSURE DROP: See Ordering Information Table, page 14.

For detailed differential pressure charts, see page 55.

ACCURACY: ±2% of full scale

REPEATABILITY: ±1%

REVERSE FLOW BY-PASS OPTION:

Features a two-piece cone that responds to flow in the primary flow direction in the same manner as the standard design.

Flow in the reverse direction causes the lower cone shuttle to shift, moving it below

the sharp-edged piston orifice, which allows the fluid to flow freely in the reverse direction.

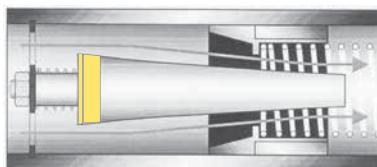

Normal Flow Direction

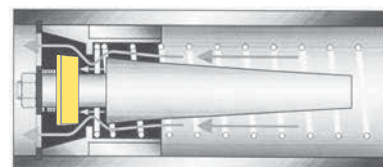

Reverse Flow By-Pass

DIMENSIONS:

	A	B	C	D
NOMINAL PORT SIZE	LENGTH in (mm)	WIDTH in (mm)	FLATS in (mm)	
¼ (SAE 6)	6.60 (168)	2.01 (53)	1.25 (32)	
½ (SAE 10)	6.60 (168)	2.01 (53)	1.25 (32)	
¾ (SAE 12)	7.20 (183)	2.48 (63)	1.50 (38)	
1 (SAE 16)	7.20 (183)	2.48 (63)	1.75 (44)	
1¼ (SAE 20)	12.20 (310)	4.20 (105)	2.75 (70)	
1½ (SAE 24)	12.20 (310)	4.20 (105)	2.75 (70)	

NOTE: Dimensions for 1½" Code 62 can be found on page 78.

Weights for all sizes can be found on page 79.

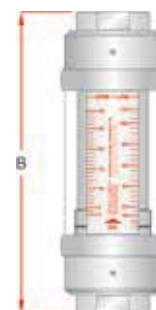

Pyrex is a registered trademark of Corning, Inc.

Teflon is a registered trademark of E.I. DuPont de Nemours & Co.

Viton is a registered trademark of DuPont Dow Elastomers

3500/6000 PSI High Temperature

Flow Meters For Petroleum Fluids

ORDERING INFORMATION:

NOMINAL PORT SIZE ^①	FLOW RANGE		PRESSURE DROP			MODEL NUMBER (see example below)			MATERIAL			OPTIONS
	GPM	LPM	50% FLOW PSI (BAR)	100% FLOW PSI (BAR)	REVERSE 100% FLOW PSI (BAR)	SAE	NPTF	BSPP	ALUMINUM 3500 PSI	BRASS 3500 PSI	STAINLESS	REVERSE FLOW
¼" SAE 6	0.1 - 1.0	0.5 - 3.75	4.0 (.28)	9.0 (.62)		H200 * - 010 - HT	H201 * - 010 - HT	H202 * - 010 - HT	A	B	S	Not Available
	0.2 - 2.0	1.0 - 7.5	6.0 (.41)	13 (.90)		H200 * - 020 - HT	H201 * - 020 - HT	H202 * - 020 - HT				
½" SAE 10	0.1 - 1.0	0.5 - 3.75	2.0 (.14)	2.75 (.19)	5.2 (.36)	H600 * - 001 - HT	H601 * - 001 - HT	H602 * - 001 - HT	A	B	S	HR
	0.2 - 2.0	1.0 - 7.5	2.0 (.14)	3.0 (.21)	9.6 (.66)	H600 * - 002 - HT	H601 * - 002 - HT	H602 * - 002 - HT				
	0.5 - 5.0	2 - 19	3.0 (.21)	6.0 (.41)	4.8 (.33)	H600 * - 005 - HT	H601 * - 005 - HT	H602 * - 005 - HT				
	1 - 10	5 - 38	4.0 (.28)	9.5 (.66)	23.0 (1.6)	H600 * - 010 - HT	H601 * - 010 - HT	H602 * - 010 - HT				
	1 - 15	4 - 56	6.5 (.45)	18.5 (1.3)	55.2 (3.8)	H600 * - 015 - HT	H601 * - 015 - HT	H602 * - 015 - HT				
¾" SAE 12	0.2 - 2.0	1 - 7.5	1.0 (.07)	2.0 (.14)	2.9 (.20)	H700 * - 002 - HT	H701 * - 002 - HT	H702 * - 002 - HT	A	B	S	HR
	0.5 - 5.0	2 - 19	2.5 (.17)	3.5 (.24)	5.3 (.37)	H700 * - 005 - HT	H701 * - 005 - HT	H702 * - 005 - HT				
	1 - 10	5 - 38	3.5 (.24)	9.0 (.62)	8.8 (.61)	H700 * - 010 - HT	H701 * - 010 - HT	H702 * - 010 - HT				
	2 - 20	10 - 76	4.0 (.28)	9.0 (.62)	18.0 (1.24)	H700 * - 020 - HT	H701 * - 020 - HT	H702 * - 020 - HT				
	3 - 30	10 - 115	7.0 (.48)	16.5 (1.1)	45.1 (3.11)	H700 * - 030 - HT	H701 * - 030 - HT	H702 * - 030 - HT				
1" SAE 16	0.2 - 2.0	1 - 7.5	1.0 (.07)	2.0 (.14)	2.9 (.20)	H760 * - 002 - HT	H761 * - 002 - HT	H762 * - 002 - HT	A	B	S	HR
	0.5 - 5.0	2 - 19	2.5 (.17)	3.5 (.24)	5.3 (.37)	H760 * - 005 - HT	H761 * - 005 - HT	H762 * - 005 - HT				
	1 - 10	5 - 38	3.5 (.24)	9.0 (.62)	8.8 (.61)	H760 * - 010 - HT	H761 * - 010 - HT	H762 * - 010 - HT				
	2 - 20	10 - 76	4.0 (.28)	9.0 (.62)	18.0 (1.24)	H760 * - 020 - HT	H761 * - 020 - HT	H762 * - 020 - HT				
	3 - 30	10 - 115	7.0 (.48)	16.5 (1.1)	45.1 (3.11)	H760 * - 030 - HT	H761 * - 030 - HT	H762 * - 030 - HT				
	4 - 40	15 - 150	9.0 (.62)	24.0 (1.7)	87.5 (6.04)	H760 * - 040 - HT	H761 * - 040 - HT	H762 * - 040 - HT				
	5 - 50	20 - 190	12.5 (.86)	34.0 (2.3)	150 (10.4)	H760 * - 050 - HT	H761 * - 050 - HT	H762 * - 050 - HT				
	5 - 50	20 - 190	12.5 (.86)	34.0 (2.3)	150 (10.4)	H760 * - 050 - HT	H761 * - 050 - HT	H762 * - 050 - HT				
1¼" SAE 20	3 - 30	10 - 110	3.0 (.21)	4.0 (.28)	4.8 (.33)	H800 * - 030 - HT	H801 * - 030 - HT	H802 * - 030 - HT	A	B	S	HR
	5 - 50	20 - 190	3.5 (.24)	7.0 (.48)	12.5 (.86)	H800 * - 050 - HT	H801 * - 050 - HT	H802 * - 050 - HT				
	10 - 75	40 - 280	5.0 (.35)	10.5 (.72)	31.9 (2.2)	H800 * - 075 - HT	H801 * - 075 - HT	H802 * - 075 - HT				
	10 - 100	50 - 380	6.5 (.45)	15 (1.0)	39.0 (2.7)	H800 * - 100 - HT	H801 * - 100 - HT	H802 * - 100 - HT				
	10 - 150	50 - 560	10.5 (.72)	27.5 (1.9)	110 (7.6)	H800 * - 150 - HT	H801 * - 150 - HT	H802 * - 150 - HT				
	10 - 150	50 - 560	10.5 (.72)	27.5 (1.9)	110 (7.6)	H800 * - 150 - HT	H801 * - 150 - HT	H802 * - 150 - HT				
1½" SAE 24	3 - 30	10 - 110	3.0 (.21)	4.0 (.28)	4.8 (.33)	H860 * - 030 - HT	H861 * - 030 - HT	H862 * - 030 - HT	A	B	S	HR
	5 - 50	20 - 190	3.5 (.24)	7.0 (.48)	12.5 (.86)	H860 * - 050 - HT	H861 * - 050 - HT	H862 * - 050 - HT				
	10 - 75	40 - 280	5.0 (.35)	10.5 (.72)	31.9 (2.2)	H860 * - 075 - HT	H861 * - 075 - HT	H862 * - 075 - HT				
	10 - 100	50 - 380	6.5 (.45)	15 (1.0)	39.0 (2.7)	H860 * - 100 - HT	H861 * - 100 - HT	H862 * - 100 - HT				
	10 - 150	50 - 560	10.5 (.72)	27.5 (1.9)	110 (7.6)	H860 * - 150 - HT	H861 * - 150 - HT	H862 * - 150 - HT				
1½" Code 62	3 - 30	10 - 110	3.0 (.21)	4.0 (.28)	4.8 (.33)	H808 * - 030 - HT			A	B	S	HR
	5 - 50	20 - 190	3.5 (.24)	7.0 (.48)	12.5 (.86)	H808 * - 050 - HT						
	10 - 75	40 - 280	5.0 (.35)	10.5 (.72)	31.9 (2.2)	H808 * - 075 - HT						
	10 - 100	50 - 380	6.5 (.45)	15 (1.0)	39.0 (2.7)	H808 * - 100 - HT						
	10 - 150	50 - 560	10.5 (.72)	27.5 (1.9)	110 (7.6)	H808 * - 150 - HT						

① Fractional sizes apply to NPTF and BSPP.

(example) H 701 **A** - 030 - **HR**

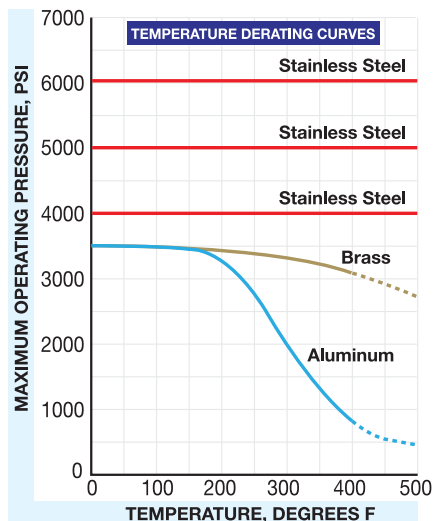

NOTE: HT suffix represents standard high temperature configuration. For reverse flow high temperature, replace HT with HR suffix.

NOTE: HR option is not available with brass flow meters.

3500/6000 PSI Flow Meters

For Phosphate Ester Fluids

- Direct reading
- Install in any position
- 360° rotatable guard/scale
- Easier-to-read linear scale
- No flow straighteners or special piping required
- Relatively insensitive to shock and vibration
- Good viscosity stability
- Temperature up to 240 °F
- Accuracy $\pm 2\%$ full scale
- Repeatability $\pm 1\%$
- Special scales available
- Calibrated for 1.18 S.G.

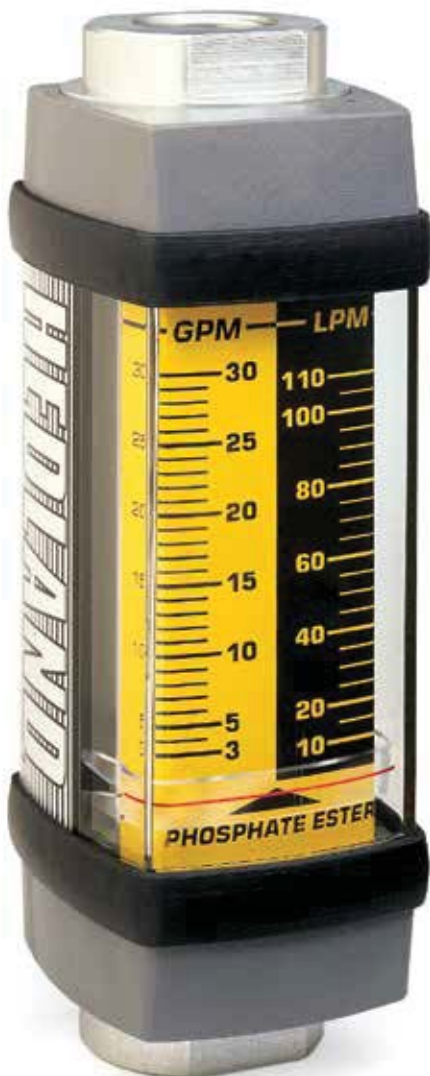

SPECIFICATIONS:

MATERIALS:

2024 - T351 Anodized aluminum body, piston and cone

C360 Brass body, piston and cone

T303 Stainless body, 2024 - T351 Anodized aluminum piston and cone

COMMON PARTS:
Retaining Ring: SAE 1070/1090 Carbon Steel
Spider Plate: T316 SS **Retaining Spring:** SAE 1070/1090 Carbon Steel
Spring: T302 SS **Indicator and Internal Magnet:** PPS / Ceramic
Fasteners: T303 SS **Guard Seal / Bumper:** EPR
Pressure Seals: EPR **Scale Support:** 6063 - T6 Aluminum
Guard: Nylon **End Caps:** Nylon ST

THREADS: SAE J1926/1, NPTF ANSI B2.2, BSPP ISO1179, Code 62: SAEJ518

TEMPERATURE RANGE: -20 to +240 °F (-29 to +116 °C) for higher temp. meters, see page 23

PRESSURE RATING:

Aluminum / Brass Operating: 3,500 psi/241 bar max. with a 3:1 safety factor.

For High Cycle Applications: See page 7

Stainless Steel Operating: 6,000 psi/414 bar max. (5,000 psi/345 bar max. for ¾" to 1½" series and 4,000 psi/276 bar max. for code 62 flange) with a 3:1 safety factor.

For High Cycle Applications: See page 7

PRESSURE DROP: See Ordering Information Table, page 18.

For detailed differential pressure charts, see page 62.

ACCURACY: $\pm 2\%$ of full scale, $\pm 7\%$ of full scale for ¼" meters **REPEATABILITY:** $\pm 1\%$

REVERSE FLOW BY-PASS OPTION: Features a two-piece cone that responds to flow in the primary flow direction in the same manner as the standard design.

Flow in the reverse direction causes the lower cone shuttle to shift, moving it below the sharp-edged piston orifice. This shift creates a gap which allows the fluid to flow freely in the reverse direction.

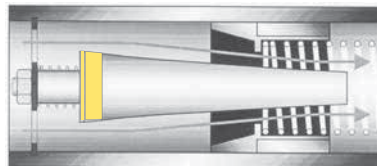

Normal Flow Direction

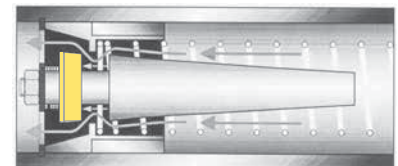

Reverse Flow By-Pass

DIMENSIONS:

A	B	C	D	E	F
NOMINAL PORT SIZE	LENGTH in (mm)	WIDTH in (mm)	DEPTH in (mm)	OFFSET in (mm)	FLATS in (mm)
¼ (SAE 6)	4.8 (122)	1.68 (43)	1.90 (48)	.84 (21)	.88 (22)
½ (SAE 10)	6.6 (168)	2.07 (53)	2.40 (61)	1.04 (26)	1.25 (32)
¾ (SAE 12)	7.2 (183)	2.48 (63)	2.85 (72)	1.24 (32)	1.50 (38)
1 (SAE 16)	7.2 (183)	2.48 (63)	2.85 (72)	1.24 (32)	1.75 (44)
1¼ (SAE 20)	12.2 (310)	4.12 (105)	4.72 (120)	2.06 (52)	2.75 (70)
1½ (SAE 24)	12.2 (310)	4.12 (105)	4.72 (120)	2.06 (52)	2.75 (70)

NOTE: Dimensions for 1-½" Code 62 can be found on page 78.

Weights for all sizes can be found on page 79.

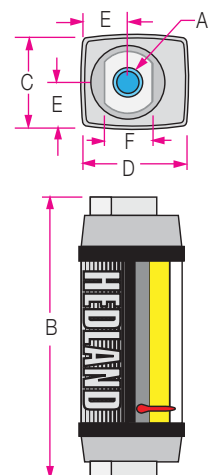

3500/6000 PSI Flow Meters

For Phosphate Ester Fluids

ORDERING INFORMATION:

NOMINAL PORT SIZE ^①	FLOW RANGE		PRESSURE DROP			MODEL NUMBER (see example below)			MATERIAL			OPTIONS
	GPM	LPM	50% FLOW PSI (BAR)	100% FLOW PSI (BAR)	REVERSE 100% FLOW PSI (BAR)	SAE	NPTF	BSPP	ALUMINUM 3500 PSI	BRASS 3500 PSI	STAINLESS	REVERSE FLOW
¼" SAE 6	.02 - 0.2	0.1 - 0.75	3.5 (.24)	4.0 (.28)		H294 * - 002 - †	H295 * - 002 - †	H296 * - 002 - †	A	B	S	6000 PSI Not Available
	.05 - 0.5	0.2 - 1.9	3.0 (.21)	5.0 (.35)		H294 * - 005 - †	H295 * - 005 - †	H296 * - 005 - †				
	0.1 - 1.0	0.5 - 3.75	4.0 (.28)	9.0 (.62)		H294 * - 010 - †	H295 * - 010 - †	H296 * - 010 - †				
	0.2 - 2.0	1.0 - 7.5	6.0 (.41)	13 (.90)		H294 * - 020 - †	H295 * - 020 - †	H296 * - 020 - †				
½" SAE 10	0.1 - 1.0	0.5 - 3.75	2.0 (.14)	2.75 (.19)	5.2 (.36)	H694 * - 001 - †	H695 * - 001 - †	H696 * - 001 - †	A	B	S	6000 PSI RF
	0.2 - 2.0	1 - 7.5	2.0 (.14)	3.0 (.21)	9.6 (.66)	H694 * - 002 - †	H695 * - 002 - †	H696 * - 002 - †				
	0.5 - 5.0	2 - 19	3.0 (.21)	6.0 (.41)	4.8 (.33)	H694 * - 005 - †	H695 * - 005 - †	H696 * - 005 - †				
	1 - 10	5 - 38	4.0 (.28)	9.5 (.66)	23.0 (1.6)	H694 * - 010 - †	H695 * - 010 - †	H696 * - 010 - †				
	1 - 15	4 - 56	6.5 (.45)	18.5 (1.3)	55.2 (3.8)	H694 * - 015 - †	H695 * - 015 - †	H696 * - 015 - †				
¾" SAE 12	0.2 - 2.0	1 - 7.5	1.0 (.07)	2.0 (.14)	2.9 (.20)	H794 * - 002 - †	H795 * - 002 - †	H796 * - 002 - †	A	B	S	5000 PSI RF
	0.5 - 5.0	2 - 19	2.5 (.17)	3.5 (.24)	5.3 (.37)	H794 * - 005 - †	H795 * - 005 - †	H796 * - 005 - †				
	1 - 10	5 - 38	3.5 (.24)	9.0 (.62)	8.8 (.61)	H794 * - 010 - †	H795 * - 010 - †	H796 * - 010 - †				
	2 - 20	10 - 76	4.0 (.28)	9.0 (.62)	18.0 (1.24)	H794 * - 020 - †	H795 * - 020 - †	H796 * - 020 - †				
	3 - 30	10 - 115	7.0 (.48)	16.5 (1.1)	45.1 (3.11)	H794 * - 030 - †	H795 * - 030 - †	H796 * - 030 - †				
1" SAE 16	0.2 - 2.0	1 - 7.5	1.0 (.07)	2.0 (.14)	2.9 (.20)	H764 * - 002 - †	H765 * - 002 - †	H766 * - 002 - †	A	B	S	5000 PSI RF
	0.5 - 5.0	2 - 19	2.5 (.17)	3.5 (.24)	5.3 (.37)	H764 * - 005 - †	H765 * - 005 - †	H766 * - 005 - †				
	1 - 10	5 - 38	3.5 (.24)	9.0 (.62)	8.8 (.61)	H764 * - 010 - †	H765 * - 010 - †	H766 * - 010 - †				
	2 - 20	10 - 76	4.0 (.28)	9.0 (.62)	18.0 (1.24)	H764 * - 020 - †	H765 * - 020 - †	H766 * - 020 - †				
	3 - 30	10 - 115	7.0 (.48)	16.5 (1.1)	45.1 (3.11)	H764 * - 030 - †	H765 * - 030 - †	H766 * - 030 - †				
	4 - 40	15 - 150	9.0 (.62)	24.0 (1.7)	87.5 (6.04)	H764 * - 040 - †	H765 * - 040 - †	H766 * - 040 - †				
	5 - 50	20 - 190	12.5 (.86)	34.0 (2.3)	150 (10.4)	H764 * - 050 - †	H765 * - 050 - †	H766 * - 050 - †				
1¼" SAE 20	3 - 30	10 - 110	3.0 (.21)	4.0 (.28)	4.8 (.33)	H894 * - 030 - †	H895 * - 030 - †	H896 * - 030 - †	A	B	S	5000 PSI RF
	5 - 50	20 - 190	3.5 (.24)	7.0 (.48)	12.5 (.86)	H894 * - 050 - †	H895 * - 050 - †	H896 * - 050 - †				
	10 - 75	40 - 280	5.0 (.35)	10.5 (.72)	31.9 (2.2)	H894 * - 075 - †	H895 * - 075 - †	H896 * - 075 - †				
	10 - 100	50 - 380	6.5 (.45)	15.0 (1.0)	39.0 (2.7)	H894 * - 100 - †	H895 * - 100 - †	H896 * - 100 - †				
	10 - 150	50 - 560	10.5 (.72)	27.5 (1.9)	110 (7.6)	H894 * - 150 - †	H895 * - 150 - †	H896 * - 150 - †				
1½" SAE 24	3 - 30	10 - 110	3.0 (.21)	4.0 (.28)	4.8 (.33)	H864 * - 030 - †	H865 * - 030 - †	H866 * - 030 - †	A	B	S	5000 PSI RF
	5 - 50	20 - 190	3.5 (.24)	7.0 (.48)	12.5 (.86)	H864 * - 050 - †	H865 * - 050 - †	H866 * - 050 - †				
	10 - 75	40 - 280	5.0 (.35)	10.5 (.72)	31.9 (2.2)	H864 * - 075 - †	H865 * - 075 - †	H866 * - 075 - †				
	10 - 100	50 - 380	6.5 (.45)	15.0 (1.0)	39.0 (2.7)	H864 * - 100 - †	H865 * - 100 - †	H866 * - 100 - †				
	10 - 150	50 - 560	10.5 (.72)	27.5 (1.9)	110 (7.6)	H864 * - 150 - †	H865 * - 150 - †	H866 * - 150 - †				
1½" Code 62	3 - 30	10 - 110	3.0 (.21)	4.0 (.28)	4.8 (.33)	H898 * - 030 - †			A	B	S	4000 PSI RF
	5 - 50	20 - 190	3.5 (.24)	7.0 (.48)	12.5 (.86)	H898 * - 050 - †						
	10 - 75	40 - 280	5.0 (.35)	10.5 (.72)	31.9 (2.2)	H898 * - 075 - †						
	10 - 100	50 - 380	6.5 (.45)	15.0 (1.0)	39.0 (2.7)	H898 * - 100 - †						
	10 - 150	50 - 560	10.5 (.72)	27.5 (1.9)	110 (7.6)	H898 * - 150 - †						

①Fractional sizes apply to NPTF and BSPP.

NOTE: RF option is not available with standard brass flow meters.

(example) H 795 A - 030 - RF

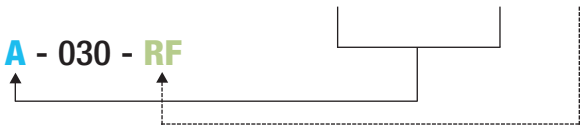

3500/6000 PSI Test Kits

For Phosphate Ester Fluids

- Direct reading
- Install in any position
- 360° rotatable guard/scale
- Easier-to-read linear scale
- No flow straighteners or special piping required
- Relatively insensitive to shock and vibration
- Good viscosity stability
- Temperature up to 240 °F
- Accuracy $\pm 2\%$ full scale
- Repeatability $\pm 1\%$
- Special scales available
- Calibrated for 1.18 S.G.

SPECIFICATIONS:

MATERIALS:

2024 - T351 Anodized aluminum body, piston and cone

C360 Brass body, piston and cone

T303 Stainless body, 2024 - T351 Anodized aluminum piston and cone

COMMON PARTS:
Spider Plate: T316 SS
Spring: T302 SS
Fasteners: T303 SS
Pressure Seals: EPR
Guard: Nylon

Retaining Ring: SAE 1070/1090 Carbon Steel
Retaining Spring: SAE 1070/1090 Carbon Steel
Indicator and Internal Magnet: PPS / Ceramic
Guard Seal / Bumper: EPR
Scale Support: 6063-T6 Aluminum
End Caps: Nylon ST

THREADS: SAE J1926/1, NPTF ANSI B2.2, BSPP ISO1179

TEMPERATURE RANGE: -20 to +240 °F (-29 to +116 °C)

PRESSURE RATING:

Aluminum / Brass Operating: 3,500 psi/241 bar max. with a 3:1 safety factor.

For High Cycle Applications: See page 7

Stainless Steel Operating: 6,000 psi/414 bar max. (5,000 psi/345 bar max. for $\frac{3}{4}$ " series) with a 3:1 safety factor.

For High Cycle Applications: See page 7

PRESSURE DROP: See Ordering Information Table, page 20.

For detailed differential pressure charts, see page 62.

ACCURACY: $\pm 2\%$ of full scale

REPEATABILITY: $\pm 1\%$

PRESSURE GAUGE: Glycerin dampened, 0 - 3,500 psi / 0 - 240 bar pressure range available on aluminum and brass test kits.

Glycerin dampened, 0 - 6,000 psi / 0 - 400 bar pressure range available on stainless steel test kits.

LOAD VALVE: $\frac{1}{2}$ ", $\frac{3}{4}$ " and 1" series - needle valve;

Produce ΔP up to 3,500 psi/241 bar PSID and 6,000 psi/414 bar PSID.



DIMENSIONS:

	A	B	B ₁	C	D	E	F
NOMINAL PORT SIZE	LENGTH in (mm)	LENGTH in (mm)	LENGTH in (mm)	WIDTH in (mm)	DEPTH in (mm)	OFFSET in (mm)	FLATS in (mm)
$\frac{1}{2}$ (SAE 10)	6.6 (168)	10.3 (262)	2.07 (53)	2.40 (61)	1.04 (26)	1.25 (32)	
$\frac{3}{4}$ (SAE 12)	7.2 (183)	11.3 (287)	2.48 (63)	2.85 (72)	1.24 (32)	1.50 (38)	
1 (SAE 16)	7.2 (183)	11.3 (287)	2.48 (63)	2.85 (72)	1.24 (32)	1.75 (44)	

NOTE: Weights for all sizes can be found on page 79.

SAE and BSPP Test Kits include inlet adapter.

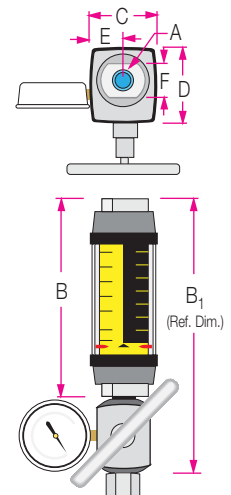

3500/6000 PSI Test Kits

For Phosphate Ester Fluids

ORDERING INFORMATION:

NOMINAL PORT SIZE ^①	FLOW RANGE		PRESSURE DROP			MODEL NUMBER (see example below)			MATERIAL			OPTIONS
	GPM	LPM	50% FLOW PSI (BAR)	100% FLOW PSI (BAR)	REVERSE 100% FLOW PSI (BAR)	SAE	NPTF	BSPP	ALUMINUM 3500 PSI	BRASS 3500 PSI	STAINLESS	REVERSE FLOW
½" SAE 10	0.1 - 1.0	0.5 - 3.75	3.0 (.21)	4.75 (.33)	7.2 (.50)	H694 * - 001 - TK	H695 * - 001 - TK	H696 * - 001 - TK	A	B	S	RT
	0.2 - 2.0	1 - 7.5	5.0 (.34)	9.0 (.62)	15.6 (1.1)	H694 * - 002 - TK	H695 * - 002 - TK	H696 * - 002 - TK				
	0.5 - 5.0	2 - 19	10.0 (.69)	26.0 (1.8)	24.8 (1.7)	H694 * - 005 - TK	H695 * - 005 - TK	H696 * - 005 - TK				
	1 - 10	5 - 38	24.0 (1.7)	71.5 (4.9)	85.0 (5.9)	H694 * - 010 - TK	H695 * - 010 - TK	H696 * - 010 - TK				
	1 - 15	4 - 56	39.0 (2.7)	155 (10.7)	210 (14.5)	H694 * - 015 - TK	H695 * - 015 - TK	H696 * - 015 - TK				
¾" SAE 12	0.2 - 2.0	1 - 7.5	1.5 (.10)	3.0 (.21)	3.9 (.27)	H794 * - 002 - TK	H795 * - 002 - TK	H796 * - 002 - TK	A	B	S	RT
	0.5 - 5.0	2 - 19	4.0 (.28)	6.5 (.45)	8.3 (.57)	H794 * - 005 - TK	H795 * - 005 - TK	H796 * - 005 - TK				
	1 - 10	5 - 38	6.5 (.45)	16.0 (1.1)	15.8 (1.1)	H794 * - 010 - TK	H795 * - 010 - TK	H796 * - 010 - TK				
	2 - 20	10 - 76	11.0 (.76)	26.0 (1.8)	35.0 (2.4)	H794 * - 020 - TK	H795 * - 020 - TK	H796 * - 020 - TK				
	3 - 30	10 - 115	18.0 (1.2)	47.5 (3.3)	76.1 (5.2)	H794 * - 030 - TK	H795 * - 030 - TK	H796 * - 030 - TK				
1" SAE 16	0.2 - 2.0	1 - 7.5	1.5 (.10)	3.0 (.21)	3.9 (.27)	H764 * - 002 - TK	H765 * - 002 - TK	H766 * - 002 - TK	A	B	S	RT
	0.5 - 5.0	2 - 19	4.0 (.28)	6.5 (.45)	8.3 (.57)	H764 * - 005 - TK	H765 * - 005 - TK	H766 * - 005 - TK				
	1 - 10	5 - 38	6.5 (.45)	16.0 (1.1)	15.8 (1.1)	H764 * - 010 - TK	H765 * - 010 - TK	H766 * - 010 - TK				
	2 - 20	10 - 76	11.0 (.76)	26.0 (1.8)	35.0 (2.4)	H764 * - 020 - TK	H765 * - 020 - TK	H766 * - 020 - TK				
	3 - 30	10 - 115	18.0 (1.2)	47.5 (3.3)	76.1 (5.2)	H764 * - 030 - TK	H765 * - 030 - TK	H766 * - 030 - TK				
	4 - 40	15 - 150	26.0 (1.8)	75.0 (5.2)	139 (9.6)	H764 * - 040 - TK	H765 * - 040 - TK	H766 * - 040 - TK				
	5 - 50	20 - 190	63.5 (4.4)	114 (7.9)	230 (15.9)	H764 * - 050 - TK	H765 * - 050 - TK	H766 * - 050 - TK				

①Fractional sizes apply to NPTF and BSPP.

(example) H 795 **A** - 030 - **RT**

NOTE: TK suffix represents standard test kit configuration. For reverse flow by-pass test kit, replace TK suffix with RT suffix.

NOTE: RT option is not available with standard brass flow meters.

REVERSE FLOW BY-PASS OPTION: Features a two-piece cone that responds to flow in the primary flow direction in the same manner as the standard design. Flow in the reverse direction causes the lower cone shuttle to shift, moving it below the sharp-edged piston orifice. This shift creates a gap which allows the fluid to flow freely in the reverse direction.

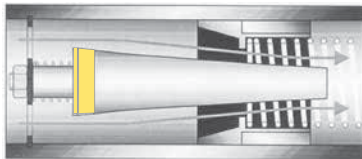

Normal Flow Direction

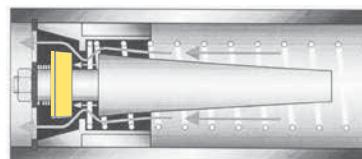

Reverse Flow By-Pass

3500/5000 PSI Test Kits

For Phosphate Ester Fluids (1-1/4" and 1-1/2")

- Direct reading
- Install in any position
- 360° rotatable guard/scale
- Easier-to-read linear scale
- No flow straighteners or special piping required
- Relatively insensitive to shock and vibration
- Good viscosity stability
- Temperature up to 240 °F
- Accuracy $\pm 2\%$ full scale
- Repeatability $\pm 1\%$
- Special scales available
- Calibrated for 1.18 S.G.



SPECIFICATIONS:

MATERIALS:

2024 - T351 Anodized aluminum body, piston and cone
 T303 Stainless body, 2024 - T351 Anodized aluminum piston and cone

COMMON PARTS:
Retaining Ring: SAE 1070/1090 Carbon Steel
Spider Plate: T316 SS **Retaining Spring:** SAE 1070/1090 Carbon Steel
Spring: T302 SS **Indicator and Internal Magnet:** PPS / Ceramic
Fasteners: T303 SS **Guard Seal / Bumper:** EPR
Pressure Seals: EPR **Scale Support:** 6063-T6 Aluminum
Guard: Nylon **End Caps:** Nylon ST

THREADS: NPT

TEMPERATURE RANGE: -20 to +240 °F (-29 to +116 °C)

PRESSURE RATING:

Aluminum Operating: 3,500 psi/241 bar max. with a 3:1 safety factor.

For High Cycle Applications: See page 7

Stainless Steel Operating: 5,000 psi/345 bar max. with a 3:1 safety factor.

For High Cycle Applications: See page 7

PRESSURE DROP: See Ordering Information Table, page 22.

For detailed differential pressure charts, see page 62.

ACCURACY: $\pm 2\%$ of full scale

REPEATABILITY: $\pm 1\%$

PRESSURE GAUGE: Glycerin dampened, 0 - 3,500 psi / 0 - 240 bar pressure range available on aluminum test kits.

Glycerin dampened, 0 - 6,000 psi / 0 - 400 bar pressure range available on stainless steel test kits.

LOAD VALVE: Produce ΔP up to 3,500 psi/241 bar PSID and 5,000 psi/345 bar PSID.

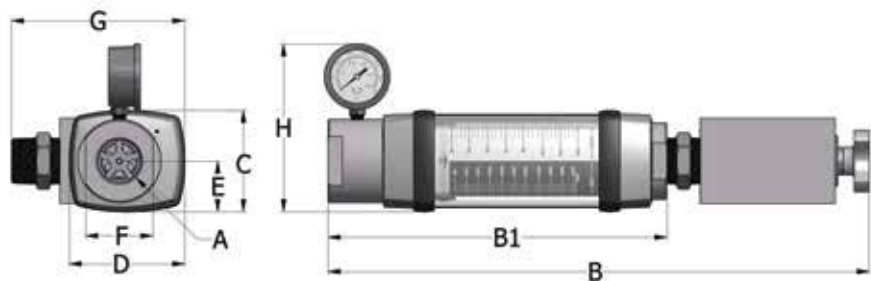

DIMENSIONS:

A	B	B ₁	C	D	E	F	G	H
NOMINAL PORT SIZE	LENGTH in (mm)	LENGTH in (mm)	WIDTH in (mm)	DEPTH in (mm)	OFFSET in (mm)	FLATS in (mm)	DEPTH in (mm)	WIDTH in (mm)
1-1/4	22.1 (561)	13.9 (353)	4.15 (105)	4.75 (121)	2.08 (53)	2.75 (70)	7.1 (180)	6.9 (175)
1-1/2	22.1 (561)	13.9 (353)	4.15 (105)	4.75 (121)	2.08 (53)	2.75 (70)	7.1 (180)	6.9 (175)

NOTE: Weights for all sizes can be found on page 79.

Pressures above 7500 PSI will pop the rupture disc allowing fluid flow to continue. This is a fail safe mechanism.

3500/5000 PSI Test Kits

For Phosphate Ester Fluids

ORDERING INFORMATION:

NOMINAL PORT SIZE	FLOW RANGE		PRESSURE DROP			MODEL NUMBER (see example below)	MATERIAL		OPTIONS
	GPM	LPM	50% FLOW PSI (BAR)	100% FLOW PSI (BAR)	REVERSE 100% FLOW PSI (BAR)	NPT	ALUMINUM 3500 PSI	STAINLESS 5000 PSI	REVERSE FLOW
1¼"	3 - 30	10 - 110	3.4 (.23)	7.8 (.54)	5.6 (.39)	H TK 895 * - 030	A	S	RT
	5 - 50	20 - 190	4.3 (.30)	8.8 (6.1)	14.3 (.99)	H TK 895 * - 050			
	10 - 75	40 - 280	6.3 (.43)	14.3 (9.9)	35.7 (2.5)	H TK 895 * - 075			
	10 - 100	50 - 380	8.3 (.57)	21.3 (1.5)	45.3 (3.1)	H TK 895 * - 100			
	10 - 150	50 - 560	14.3 (.99)	41.3 (2.8)	124 (8.6)	H TK 895 * - 150			
1½"	3 - 30	10 - 110	3.4 (.23)	7.8 (.54)	5.6 (.39)	H TK 865 * - 030	A	S	RT
	5 - 50	20 - 190	4.3 (.30)	8.8 (6.1)	14.3 (.99)	H TK 865 * - 050			
	10 - 75	40 - 280	6.3 (.43)	14.3 (9.9)	35.7 (2.5)	H TK 865 * - 075			
	10 - 100	50 - 380	8.3 (.57)	21.3 (1.5)	45.3 (3.1)	H TK 865 * - 100			
	10 - 150	50 - 560	14.3 (.99)	41.3 (2.8)	124 (8.6)	H TK 865 * - 150			

(example) H RT 895 A - 030

NOTE: TK suffix represents standard test kit configuration. For reverse flow by-pass test kit, replace TK suffix with RT suffix.

REVERSE FLOW BY-PASS OPTION: Features a two-piece cone that responds to flow in the primary flow direction in the same manner as the standard design. Flow in the reverse direction causes the lower cone shuttle to shift, moving it below the sharp-edged piston orifice. This shift creates a gap which allows the fluid to flow freely in the reverse direction.

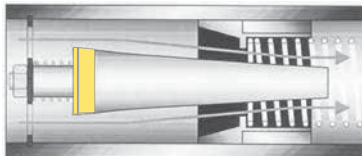

Normal Flow Direction

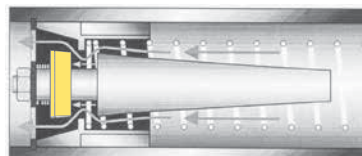

Reverse Flow By-Pass

3500/6000 PSI High Temperature

Flow Meters For Phosphate Ester Fluids

- Direct reading
- Install in any position
- 360° rotatable guard/scale
- Easier-to-read linear scale
- No flow straighteners or special piping required
- Relatively insensitive to shock and vibration
- Good viscosity stability
- Temperature up to 500 °F
- Accuracy $\pm 2\%$ full scale
- Repeatability $\pm 1\%$
- Special scales available
- Calibrated for 1.18 S.G.

SPECIFICATIONS:

MATERIALS:

2024 - T351 Anodized aluminum body, piston and cone

C360 Brass body, piston and cone

T303 Stainless body, 2024 - T351 Anodized aluminum piston and cone

COMMON PARTS:

Spider Plate: T316 SS

Spring: T302 SS

Fasteners: T303 SS

Seals: EPR

Scale Support: T316 SS

Scale: Polyimide

Retaining Ring: SAE 1070/1090 Carbon Steel

Retaining Spring: SAE 1070/1090 Carbon Steel

Indicator: Nickel-plated Carbon Steel

Internal Magnet: Teflon® Coated Alnico 8

Bumper: 2011 - T3 Anodized Aluminum

Guard: Cylindrical Pyrex® Glass

End Caps: 2011 - T3 Anodized Aluminum

THREADS: SAE J1926/1, NPTF ANSI B2.2, BSPP ISO1179, **Code 62:** SAEJ518

TEMPERATURE RANGE: -20 to +400 °F (-29 to +205 °C) Continuous

+400 to +500 °F (+205 to +260 °C) Intermittent

For detailed "Pressure vs. Temperature" correlation information, see page 20.

PRESSURE RATING:

Aluminum / Brass Operating: 3,500 psi/241 bar max. with a 3:1 safety factor.

For High Cycle Applications: See page 7

Stainless Steel Operating: 6,000 psi/414 bar max. (5,000 psi/345 bar max.

for ¾" to 1½" series) with a 3:1 safety factor.

For High Cycle Applications: See page 7

PRESSURE DROP: See Ordering Information Table, page 24

For detailed differential pressure charts, see page 62.

ACCURACY: $\pm 2\%$ of full scale

REPEATABILITY: $\pm 1\%$

REVERSE FLOW BY-PASS OPTION: Features a two-piece cone that responds to flow in the primary flow direction in the same manner as the standard design.

Flow in the reverse direction causes the lower cone shuttle to shift, moving it below the sharp-edged piston orifice, which allows the fluid to flow freely in the reverse direction.

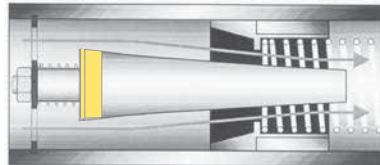

Normal Flow Direction

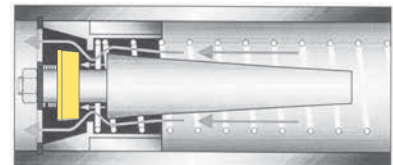

Reverse Flow By-Pass

DIMENSIONS:

A	B	C	D
NOMINAL PORT SIZE	LENGTH in (mm)	WIDTH in (mm)	FLATS in (mm)
¼ (SAE 6)	6.60 (168)	2.01 (53)	1.25 (32)
½ (SAE 10)	6.60 (168)	2.01 (53)	1.25 (32)
¾ (SAE 12)	7.20 (183)	2.48 (63)	1.50 (38)
1 (SAE 16)	7.20 (183)	2.48 (63)	1.75 (44)
1¼ (SAE 20)	12.20 (310)	4.20 (105)	2.75 (70)
1½ (SAE 24)	12.20 (310)	4.20 (105)	2.75 (70)

NOTE: Dimensions for 1½" Code 62 can be found on page 78.

Weights for all sizes can be found on page 79.



3500/6000 PSI High Temperature Flow Meters For Phosphate Ester Fluids

ORDERING INFORMATION:

NOMINAL PORT SIZE ^①	FLOW RANGE		PRESSURE DROP			MODEL NUMBER (see example below)			MATERIAL			OPTIONS
	GPM	LPM	50% FLOW PSI (BAR)	100% FLOW PSI (BAR)	REVERSE 100% FLOW PSI (BAR)	SAE	NPTF	BSPP	ALUMINUM 3500 PSI	BRASS 3500 PSI	STAINLESS	REVERSE FLOW
¼" SAE 6	0.1 - 1.0	0.5 - 3.75	4.0 (.28)	9.0 (.62)		H294 * - 010 - HT	H295 * - 010 - HT	H296 * - 010 - HT	A	B	6000 PSI S	Not Available
	0.2 - 2.0	1.0 - 7.5	6.0 (.41)	13 (.90)		H294 * - 020 - HT	H295 * - 020 - HT	H296 * - 020 - HT				
½" SAE 10	0.1 - 1.0	0.5 - 3.75	2.0 (.14)	2.75 (.19)	5.2 (.36)	H694 * - 001 - HT	H695 * - 001 - HT	H696 * - 001 - HT	A	B	6000 PSI S	HR
	0.2 - 2.0	1 - 7.5	2.0 (.14)	3.0 (.21)	9.6 (.66)	H694 * - 002 - HT	H695 * - 002 - HT	H696 * - 002 - HT				
	0.5 - 5.0	2 - 19	3.0 (.21)	6.0 (.41)	4.8 (.33)	H694 * - 005 - HT	H695 * - 005 - HT	H696 * - 005 - HT				
	1 - 10	5 - 38	4.0 (.28)	9.5 (.66)	23.0 (1.6)	H694 * - 010 - HT	H695 * - 010 - HT	H696 * - 010 - HT				
	1 - 15	4 - 56	6.5 (.45)	18.5 (1.3)	55.2 (3.8)	H694 * - 015 - HT	H695 * - 015 - HT	H696 * - 015 - HT				
¾" SAE 12	0.2 - 2.0	1 - 7.5	1.0 (.07)	2.0 (.14)	2.9 (.20)	H794 * - 002 - HT	H795 * - 002 - HT	H796 * - 002 - HT	A	B	5000 PSI S	HR
	0.5 - 5.0	2 - 19	2.5 (.17)	3.5 (.24)	5.3 (.37)	H794 * - 005 - HT	H795 * - 005 - HT	H796 * - 005 - HT				
	1 - 10	5 - 38	3.5 (.24)	9.0 (.62)	8.8 (.61)	H794 * - 010 - HT	H795 * - 010 - HT	H796 * - 010 - HT				
	2 - 20	10 - 76	4.0 (.28)	9.0 (.62)	18.0 (1.24)	H794 * - 020 - HT	H795 * - 020 - HT	H796 * - 020 - HT				
	3 - 30	10 - 115	7.0 (.48)	16.5 (1.1)	45.1 (3.11)	H794 * - 030 - HT	H795 * - 030 - HT	H796 * - 030 - HT				
1" SAE 16	0.2 - 2.0	1 - 7.5	1.0 (.07)	2.0 (.14)	2.9 (.20)	H764 * - 002 - HT	H765 * - 002 - HT	H766 * - 002 - HT	A	B	5000 PSI S	HR
	0.5 - 5.0	2 - 19	2.5 (.17)	3.5 (.24)	5.3 (.37)	H764 * - 005 - HT	H765 * - 005 - HT	H766 * - 005 - HT				
	1 - 10	5 - 38	3.5 (.24)	9.0 (.62)	8.8 (.61)	H764 * - 010 - HT	H765 * - 010 - HT	H766 * - 010 - HT				
	2 - 20	10 - 76	4.0 (.28)	9.0 (.62)	18.0 (1.24)	H764 * - 020 - HT	H765 * - 020 - HT	H766 * - 020 - HT				
	3 - 30	10 - 115	7.0 (.48)	16.5 (1.1)	45.1 (3.11)	H764 * - 030 - HT	H765 * - 030 - HT	H766 * - 030 - HT				
1¼" SAE 20	3 - 30	10 - 110	3.0 (.21)	4.0 (.28)	4.8 (.33)	H894 * - 030 - HT	H895 * - 030 - HT	H896 * - 030 - HT	A	B	5000 PSI S	HR
	5 - 50	20 - 190	3.5 (.24)	7.0 (.48)	12.5 (.86)	H894 * - 050 - HT	H895 * - 050 - HT	H896 * - 050 - HT				
	10 - 75	40 - 280	5.0 (.35)	10.5 (.72)	31.9 (2.2)	H894 * - 075 - HT	H895 * - 075 - HT	H896 * - 075 - HT				
	10 - 100	50 - 380	6.5 (.45)	15.0 (1.0)	39.0 (2.7)	H894 * - 100 - HT	H895 * - 100 - HT	H896 * - 100 - HT				
	10 - 150	50 - 560	10.5 (.72)	27.5 (1.9)	110 (7.6)	H894 * - 150 - HT	H895 * - 150 - HT	H896 * - 150 - HT				
1½" SAE 24	3 - 30	10 - 110	3.0 (.21)	4.0 (.28)	4.8 (.33)	H864 * - 030 - HT	H865 * - 030 - HT	H866 * - 030 - HT	A	B	5000 PSI S	HR
	5 - 50	20 - 190	3.5 (.24)	7.0 (.48)	12.5 (.86)	H864 * - 050 - HT	H865 * - 050 - HT	H866 * - 050 - HT				
	10 - 75	40 - 280	5.0 (.35)	10.5 (.72)	31.9 (2.2)	H864 * - 075 - HT	H865 * - 075 - HT	H866 * - 075 - HT				
	10 - 100	50 - 380	6.5 (.45)	15.0 (1.0)	39.0 (2.7)	H864 * - 100 - HT	H865 * - 100 - HT	H866 * - 100 - HT				
	10 - 150	50 - 560	10.5 (.72)	27.5 (1.9)	110 (7.6)	H864 * - 150 - HT	H865 * - 150 - HT	H866 * - 150 - HT				
1½" Code 62	3 - 30	10 - 110	3.0 (.21)	4.0 (.28)	4.8 (.33)	H898 * - 030 - HT			A	B	4000 PSI S	HR
	5 - 50	20 - 190	3.5 (.24)	7.0 (.48)	12.5 (.86)	H898 * - 050 - HT						
	10 - 75	40 - 280	5.0 (.35)	10.5 (.72)	31.9 (2.2)	H898 * - 075 - HT						
	10 - 100	50 - 380	6.5 (.45)	15.0 (1.0)	39.0 (2.7)	H898 * - 100 - HT						
	10 - 150	50 - 560	10.5 (.72)	27.5 (1.9)	110 (7.6)	H898 * - 150 - HT						

① Fractional sizes apply to NPTF and BSPP.

(example) H 795 **A** - 030 - **HR**

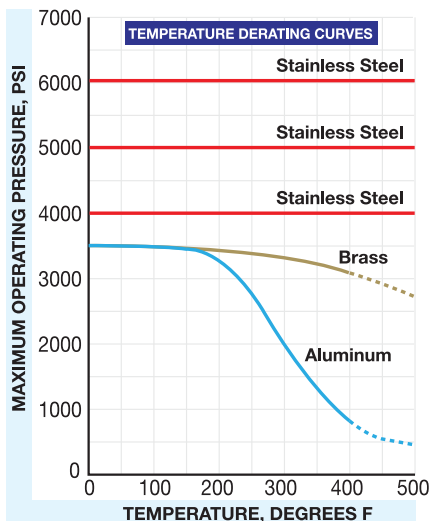

— CONTINUOUS TEMPERATURE
 - - - - - INTERMITTENT TEMPERATURE

NOTE: HT suffix represents standard high temperature configuration. For reverse flow high temperature, replace HT with HR suffix.

NOTE: HR option is not available with brass flow meters.

3500/6000 PSI Flow Meters

For Water-based Fluids (Water/Oil Emulsions)

- Direct reading
- Install in any position
- 360° rotatable guard/scale
- Easier-to-read linear scale
- No flow straighteners or special piping required
- Relatively insensitive to shock and vibration
- Good viscosity stability
- Temperature up to 240 °F
- Accuracy $\pm 2\%$ full scale
- Repeatability $\pm 1\%$
- Special scales available
- Calibrated for 1.0 S.G.
- For 80/20 and other water/oil emulsions

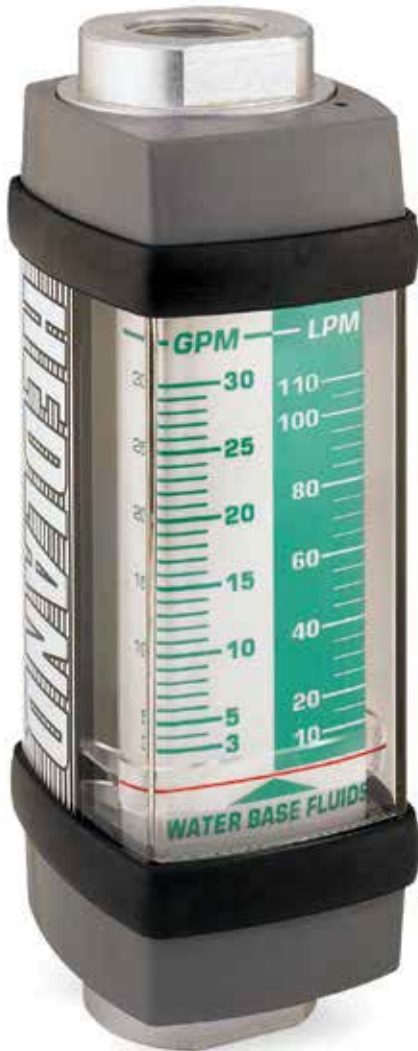

SPECIFICATIONS:

MATERIALS:

2024 - T351 Anodized aluminum body, piston and cone

C360 Brass body, piston and cone[Ⓞ]

T303 Stainless body, 2024 - T351 Anodized aluminum piston and cone

COMMON PARTS: Retaining Ring: T316 SS
Spider Plate: T316 SS Retaining Spring: T316 SS
Spring: T302 SS Indicator and Internal Magnet: PPS / Ceramic
Fasteners: T303 SS Guard Seal / Bumper: Buna N
Pressure Seals: Viton[®] Scale Support: 6063 - T6 Aluminum
Guard: Polycarbonate End Caps: Nylon ST

THREADS: SAE J1926/1, NPTF ANSI B2.2, BSPP ISO1179, Code 61 and Code 62: SAEJ518

TEMPERATURE RANGE: -20 to +240 °F (-29 to +116 °C) for higher temp. meters, see page 31.

PRESSURE RATING:

Aluminum / Brass Operating: 3,500 psi/241 bar max. (800 psi/55 bar max. for 3" series) with a 3:1 safety factor.

For High Cycle Applications: See page 7

Stainless Steel Operating: 6,000 psi/414 bar max. (5,000 psi/345 bar max. for ¾" to 1½" series and 4,000 psi/276 bar max. for code 62 flange) with a 3:1 safety factor.

For High Cycle Applications: See page 7

PRESSURE DROP: See Ordering Information Table, page 26.

For detailed differential pressure charts, see page 63.

ACCURACY: $\pm 2\%$ of full scale, $\pm 7\%$ of full scale for ¼" meters **REPEATABILITY:** $\pm 1\%$

REVERSE FLOW BY-PASS OPTION: Features a two-piece cone that responds to flow in the primary flow direction in the same manner as the standard design. Flow in the reverse direction causes the lower cone shuttle to shift, moving it below the sharp-edged piston orifice. This shift creates a gap which allows the fluid to flow freely in the reverse direction.

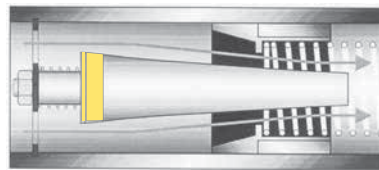

Normal Flow Direction

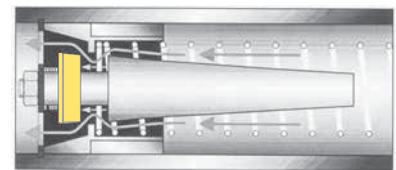

Reverse Flow By-Pass

DIMENSIONS:

A	B	C	D	E	F
NOMINAL PORT SIZE	LENGTH in (mm)	WIDTH in (mm)	DEPTH in (mm)	OFFSET in (mm)	FLATS in (mm)
¼ (SAE 6)	4.8 (122)	1.68 (43)	1.90 (48)	.84 (21)	.88 (22)
½ (SAE 10)	6.6 (168)	2.07 (53)	2.40 (61)	1.04 (26)	1.25 (32)
¾ (SAE 12)	7.2 (183)	2.48 (63)	2.85 (72)	1.24 (32)	1.50 (38)
1 (SAE 16)	7.2 (183)	2.48 (63)	2.85 (72)	1.24 (32)	1.75 (44)
1½ (SAE 20)	12.2 (310)	4.12 (105)	4.72 (120)	2.06 (52)	2.75 (70)
1½ (SAE 24)	12.2 (310)	4.12 (105)	4.72 (120)	2.06 (52)	2.75 (70)

NOTE: Dimensions for 1½" Code 62, 3" and 3" Code 61 can be found on page 78.

Weights for all sizes can be found on page 79.

[Ⓞ]3 inch models have Celcon[®] piston/piston ring

Celcon is a registered trademark of Hoechst Celanese Corp. Viton is a registered trademark of DuPont Dow Elastomers

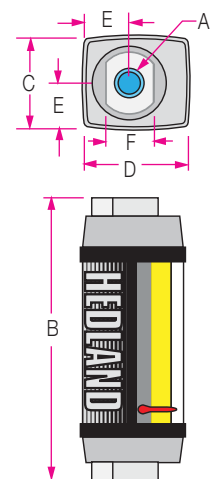

3500/6000 PSI Flow Meters

For Water-based Fluids (Water/Oil Emulsions)

ORDERING INFORMATION:

NOMINAL PORT SIZE ^②	FLOW RANGE		PRESSURE DROP			MODEL NUMBER (see example below)			MATERIAL			OPTIONS
	GPM	LPM	50% FLOW PSI (BAR)	100% FLOW PSI (BAR)	REVERSE 100% FLOW PSI (BAR)	SAE	NPTF	BSPP ^③	ALUMINUM 3500 PSI	BRASS 3500 PSI	STAINLESS	REVERSE FLOW
¼" SAE 6	.02 - 0.2	0.1 - 0.75	3.5 (.24)	4.0 (.28)		H212 * - 002 - †	H213 * - 002 - †	H214 * - 002 - †	A	B	S	6000 PSI Not Available
	.05 - 0.5	0.2 - 1.9	3.0 (.21)	5.0 (.35)		H212 * - 005 - †	H213 * - 005 - †	H214 * - 005 - †				
	0.1 - 1.0	0.5 - 3.75	4.0 (.28)	9.0 (.62)		H212 * - 010 - †	H213 * - 010 - †	H214 * - 010 - †				
	0.2 - 2.0	1 - 7.5	6.0 (.41)	13 (.90)		H212 * - 020 - †	H213 * - 020 - †	H214 * - 020 - †				
½" SAE 10	0.1 - 1.0	0.5 - 3.75	2.0 (.14)	2.75 (.19)	5.2 (.36)	H612 * - 001 - †	H613 * - 001 - †	H614 * - 001 - †	A	B	S	6000 PSI RF
	0.2 - 2.0	1 - 7.5	2.0 (.14)	3.0 (.21)	9.6 (.66)	H612 * - 002 - †	H613 * - 002 - †	H614 * - 002 - †				
	0.5 - 5.0	2 - 19	3.0 (.21)	6.0 (.41)	4.8 (.33)	H612 * - 005 - †	H613 * - 005 - †	H614 * - 005 - †				
	1 - 10	5 - 38	4.0 (.28)	9.5 (.66)	23.0 (1.6)	H612 * - 010 - †	H613 * - 010 - †	H614 * - 010 - †				
	1 - 15	4 - 56	6.5 (.45)	18.5 (1.3)	55.2 (3.8)	H612 * - 015 - †	H613 * - 015 - †	H614 * - 015 - †				
¾" SAE 12	0.2 - 2.0	1 - 7.5	1.0 (.07)	2.0 (.14)	2.9 (.20)	H712 * - 002 - †	H713 * - 002 - †	H714 * - 002 - †	A	B	S	5000 PSI RF
	0.5 - 5.0	2 - 19	2.5 (.17)	3.5 (.24)	5.3 (.37)	H712 * - 005 - †	H713 * - 005 - †	H714 * - 005 - †				
	1 - 10	5 - 38	3.5 (.24)	9.0 (.62)	8.8 (.61)	H712 * - 010 - †	H713 * - 010 - †	H714 * - 010 - †				
	2 - 20	10 - 76	4.0 (.28)	9.0 (.62)	18.0 (1.24)	H712 * - 020 - †	H713 * - 020 - †	H714 * - 020 - †				
	3 - 30	10 - 115	7.0 (.48)	16.5 (1.1)	45.1 (3.11)	H712 * - 030 - †	H713 * - 030 - †	H714 * - 030 - †				
1" SAE 16	0.2 - 2.0	1 - 7.5	1.0 (.07)	2.0 (.14)	2.9 (.20)	H782 * - 002 - †	H783 * - 002 - †	H784 * - 002 - †	A	B	S	5000 PSI RF
	0.5 - 5.0	2 - 19	2.5 (.17)	3.5 (.24)	5.3 (.37)	H782 * - 005 - †	H783 * - 005 - †	H784 * - 005 - †				
	1 - 10	5 - 38	3.5 (.24)	9.0 (.62)	8.8 (.61)	H782 * - 010 - †	H783 * - 010 - †	H784 * - 010 - †				
	2 - 20	10 - 76	4.0 (.28)	9.0 (.62)	18.0 (1.24)	H782 * - 020 - †	H783 * - 020 - †	H784 * - 020 - †				
	3 - 30	10 - 115	7.0 (.48)	16.5 (1.1)	45.1 (3.11)	H782 * - 030 - †	H783 * - 030 - †	H784 * - 030 - †				
1¼" SAE 20	3 - 30	10 - 110	3.0 (.21)	4.0 (.28)	4.8 (.33)	H812 * - 030 - †	H813 * - 030 - †	H814 * - 030 - †	A	B	S	5000 PSI RF
	5 - 50	20 - 190	3.5 (.24)	7.0 (.48)	12.5 (.86)	H812 * - 050 - †	H813 * - 050 - †	H814 * - 050 - †				
	10 - 75	40 - 280	5.0 (.35)	10.5 (.72)	31.9 (2.2)	H812 * - 075 - †	H813 * - 075 - †	H814 * - 075 - †				
	10 - 100	50 - 380	6.5 (.45)	15.0 (1.0)	39.0 (2.7)	H812 * - 100 - †	H813 * - 100 - †	H814 * - 100 - †				
	10 - 150	50 - 560	10.5 (.72)	27.5 (1.9)	110 (7.6)	H812 * - 150 - †	H813 * - 150 - †	H814 * - 150 - †				
1½" SAE 24	3 - 30	10 - 110	3.0 (.21)	4.0 (.28)	4.8 (.33)	H882 * - 030 - †	H883 * - 030 - †	H884 * - 030 - †	A	B	S	5000 PSI RF
	5 - 50	20 - 190	3.5 (.24)	7.0 (.48)	12.5 (.86)	H882 * - 050 - †	H883 * - 050 - †	H884 * - 050 - †				
	10 - 75	40 - 280	5.0 (.35)	10.5 (.72)	31.9 (2.2)	H882 * - 075 - †	H883 * - 075 - †	H884 * - 075 - †				
	10 - 100	50 - 380	6.5 (.45)	15.0 (1.0)	39.0 (2.7)	H882 * - 100 - †	H883 * - 100 - †	H884 * - 100 - †				
	10 - 150	50 - 560	10.5 (.72)	27.5 (1.9)	110 (7.6)	H882 * - 150 - †	H883 * - 150 - †	H884 * - 150 - †				
1½" Code 62	3 - 30	10 - 110	3.0 (.21)	4.0 (.28)	4.8 (.33)	H818 * - 030 - †			A	B	S	4000 PSI RF
	5 - 50	20 - 190	3.5 (.24)	7.0 (.48)	12.5 (.86)	H818 * - 050 - †						
	10 - 75	40 - 280	5.0 (.35)	10.5 (.72)	31.9 (2.2)	H818 * - 075 - †						
	10 - 100	50 - 380	6.5 (.45)	15.0 (1.0)	39.0 (2.7)	H818 * - 100 - †						
	10 - 150	50 - 560	10.5 (.72)	27.5 (1.9)	110 (7.6)	H818 * - 150 - †						
3" Code 61	20 - 180	50 - 650	11 (.76)	17 (1.1)		Not Available	H913 * - 180	H914 * - 180	800 PSI		Not Available	
	20 - 275	100 - 1000	11 (.76)	18 (1.2)			H913 * - 275	H914 * - 275	A	B		
3" Code 61	20 - 180	50 - 650	11 (.76)	17 (1.1)		H919 * - 180			800 PSI		Not Available	
	20 - 275	100 - 1000	11 (.76)	18 (1.2)		H919 * - 275			A	B		

NOTE: RF option is not available with standard brass flow meters.

② Fractional sizes apply to NPTF and BSPP.

③ 3 inch models have BSPT (BS21) threads

⚠ CAUTION: For emulsions with less than 20% oil, factory recommends the Brass body meter.

(example) H 713 A - 030 - RF



3500/6000 PSI Test Kits

For Water-based Fluids (Water/Oil Emulsions)

- Direct reading
- Install in any position
- 360° rotatable guard/scale
- Easier-to-read linear scale
- No flow straighteners or special piping required
- Relatively insensitive to shock and vibration
- Good viscosity stability
- Temperature up to 240 °F
- Accuracy $\pm 2\%$ full scale
- Repeatability $\pm 1\%$
- Special scales available
- Calibrated for 1.0 S.G.
- For 80/20 and other water/oil emulsions

SPECIFICATIONS:

MATERIALS:

2024 - T351 Anodized aluminum body, piston and cone

C360 Brass body, piston and cone

T303 Stainless body, 2024 - T351 Anodized aluminum piston and cone

COMMON PARTS: Retaining Ring: T316 SS
 Spider Plate: T316 SS Retaining Spring: T316 SS
 Spring: T302 SS Indicator and Internal Magnet: PPS / Ceramic
 Fasteners: T303 SS Guard Seal / Bumper: Buna N
 Pressure Seals: Viton® Scale Support: 6063 - T6 Aluminum
 Guard: Polycarbonate End Caps: Nylon ST

THREADS: SAE J1926/1, NPTF ANSI B2.2, BSPP ISO1179

TEMPERATURE RANGE: -20 to +240 °F (-29 to +116 °C)

PRESSURE RATING:

Aluminum / Brass Operating: 3,500 psi/241 bar max. with a 3:1 safety factor.

For High Cycle Applications: See page 7

Stainless Steel Operating: 6,000 psi/414 bar max. (5,000 psi/345 bar max. for $\frac{3}{4}$ " series) with a 3:1 safety factor.

For High Cycle Applications: See page 7

PRESSURE DROP: See Ordering Information Table, page 28.

For detailed differential pressure charts, see page 63.

ACCURACY: $\pm 2\%$ of full scale

REPEATABILITY: $\pm 1\%$

PRESSURE GAUGE: Glycerin dampened, 0 - 3,500 psi / 0 - 240 bar pressure range available on aluminum and brass test kits.

Glycerin dampened, 0 - 6,000 psi / 0 - 400 bar pressure range available on stainless steel test kits.

LOAD VALVE: $\frac{1}{2}$ ", $\frac{3}{4}$ " and 1" series - needle valve;

Produce ΔP up to 3,500 psi/241 bar PSID and 6,000 psi/414 bar PSID.



DIMENSIONS:

A	B	B ₁	C	D	E	F
NOMINAL PORT SIZE	LENGTH in (mm)	LENGTH in (mm)	WIDTH in (mm)	DEPTH in (mm)	OFFSET in (mm)	FLATS in (mm)
$\frac{1}{2}$ (SAE 10)	6.6 (168)	10.3 (262)	2.07 (53)	2.40 (61)	1.04 (26)	1.25 (32)
$\frac{3}{4}$ (SAE 12)	7.2 (183)	11.3 (287)	2.48 (63)	2.85 (72)	1.24 (32)	1.50 (38)
1 (SAE 16)	7.2 (183)	11.3 (287)	2.48 (63)	2.85 (72)	1.24 (32)	1.75 (44)

NOTE: Weights for all sizes can be found on page 79.

SAE and BSPP Test Kits include inlet adapter.

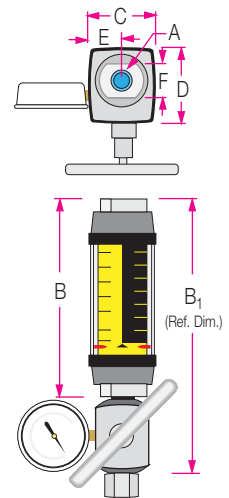

3500/6000 PSI Test Kits

For Water-based Fluids (Water/Oil Emulsions)

ORDERING INFORMATION:

NOMINAL PORT SIZE ^①	FLOW RANGE		PRESSURE DROP			MODEL NUMBER (see example below)			MATERIAL			OPTIONS
	GPM	LPM	50% FLOW PSI (BAR)	100% FLOW PSI (BAR)	REVERSE 100% FLOW PSI (BAR)	SAE	NPTF	BSPP	ALUMINUM 3500 PSI	BRASS 3500 PSI	STAINLESS	REVERSE FLOW
½" SAE 10	0.1 - 1.0	0.5 - 3.75	3.0 (.21)	4.75 (.33)	7.2 (.50)	H612 * - 001 - TK	H613 * - 001 - TK	H614 * - 001 - TK	A	B	S	RT
	0.2 - 2.0	1 - 7.5	5.0 (.34)	9.0 (.62)	15.6 (1.1)	H612 * - 002 - TK	H613 * - 002 - TK	H614 * - 002 - TK				
	0.5 - 5.0	2 - 19	10.0 (.69)	26.0 (1.8)	24.8 (1.7)	H612 * - 005 - TK	H613 * - 005 - TK	H614 * - 005 - TK				
	1 - 10	5 - 38	24.0 (1.7)	71.5 (4.9)	85.0 (5.9)	H612 * - 010 - TK	H613 * - 010 - TK	H614 * - 010 - TK				
	1 - 15	4 - 56	39.0 (2.7)	155 (10.7)	210 (14.5)	H612 * - 015 - TK	H613 * - 015 - TK	H614 * - 015 - TK				
¾" SAE 12	0.2 - 2.0	1 - 7.5	1.5 (.10)	3.0 (.21)	3.9 (.27)	H712 * - 002 - TK	H713 * - 002 - TK	H714 * - 002 - TK	A	B	S	RT
	0.5 - 5.0	2 - 19	4.0 (.28)	6.5 (.45)	8.3 (.57)	H712 * - 005 - TK	H713 * - 005 - TK	H714 * - 005 - TK				
	1 - 10	5 - 38	6.5 (.45)	16.0 (1.1)	15.8 (1.1)	H712 * - 010 - TK	H713 * - 010 - TK	H714 * - 010 - TK				
	2 - 20	10 - 76	11.0 (.76)	26.0 (1.8)	35.0 (2.4)	H712 * - 020 - TK	H713 * - 020 - TK	H714 * - 020 - TK				
	3 - 30	10 - 115	18.0 (1.2)	47.5 (3.3)	76.1 (5.2)	H712 * - 030 - TK	H713 * - 030 - TK	H714 * - 030 - TK				
1" SAE 16	0.2 - 2.0	1 - 7.5	1.5 (.10)	3.0 (.21)	3.9 (.27)	H782 * - 002 - TK	H783 * - 002 - TK	H784 * - 002 - TK	A	B	S	RT
	0.5 - 5.0	2 - 19	4.0 (.28)	6.5 (.45)	8.3 (.57)	H782 * - 005 - TK	H783 * - 005 - TK	H784 * - 005 - TK				
	1 - 10	5 - 38	6.5 (.45)	16.0 (1.1)	15.8 (1.1)	H782 * - 010 - TK	H783 * - 010 - TK	H784 * - 010 - TK				
	2 - 20	10 - 76	11.0 (.76)	26.0 (1.8)	35.0 (2.4)	H782 * - 020 - TK	H783 * - 020 - TK	H784 * - 020 - TK				
	3 - 30	10 - 115	18.0 (1.2)	47.5 (3.3)	76.1 (5.2)	H782 * - 030 - TK	H783 * - 030 - TK	H784 * - 030 - TK				
	4 - 40	15 - 150	26.0 (1.8)	75.0 (5.2)	139 (9.6)	H782 * - 040 - TK	H783 * - 040 - TK	H784 * - 040 - TK				
	5 - 50	20 - 190	63.5 (4.4)	114 (7.9)	230 (15.9)	H782 * - 050 - TK	H783 * - 050 - TK	H784 * - 050 - TK				

①Fractional sizes apply to NPTF and BSPP.

(example) H 713 A - 030 - RT



NOTE: TK suffix represents standard test kit configuration. For reverse flow by-pass test kit, replace TK suffix with RT suffix.

NOTE: RT option is not available with standard brass flow meters.

REVERSE FLOW BY-PASS OPTION: Features a two-piece cone that responds to flow in the primary flow direction in the same manner as the standard design. Flow in the reverse direction causes the lower cone shuttle to shift, moving it below the sharp-edged piston orifice. This shift creates a gap which allows the fluid to flow freely in the reverse direction.

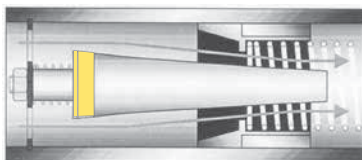

Normal Flow Direction

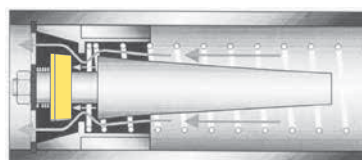

Reverse Flow By-Pass

⚠ CAUTION: For emulsions with less than 20% oil, factory recommends the Brass body meter.

3500/5000 PSI Test Kits

For Water-based Fluids (Water/Oil Emulsions) (1-1/4" and 1-1/2")

- Direct reading
- Install in any position
- 360° rotatable guard/scale
- Easier-to-read linear scale
- No flow straighteners or special piping required
- Relatively insensitive to shock and vibration
- Good viscosity stability
- Temperature up to 240 °F
- Accuracy $\pm 2\%$ full scale
- Repeatability $\pm 1\%$
- Special scales available
- Calibrated for 1.0 S.G.
- For 80/20 and other water/oil emulsions

SPECIFICATIONS:

MATERIALS:

2024 - T351 Anodized aluminum body, piston and cone

T303 Stainless body, 2024 - T351 Anodized aluminum piston and cone

COMMON PARTS:	Retaining Ring: T316 SS
Spider Plate: T316 SS	Retaining Spring: T316 SS
Spring: T302 SS	Indicator and Internal Magnet: PPS / Ceramic
Fasteners: T303 SS	Guard Seal / Bumper: Buna N
Pressure Seals: Viton®	Scale Support: 6063 - T6 Aluminum
Guard: Polycarbonate	End Caps: Nylon ST

THREADS: NPT

TEMPERATURE RANGE: -20 to +240 °F (-29 to +116 °C)

PRESSURE RATING:

Aluminum / Operating: 3,500 psi/241 bar max. with a 3:1 safety factor.

For High Cycle Applications: See page 7

Stainless Steel Operating: 5,000 psi/345 bar max. with a 3:1 safety factor.

For High Cycle Applications: See page 7

PRESSURE DROP: See Ordering Information Table, page 30.

For detailed differential pressure charts, see page 57.

ACCURACY: $\pm 2\%$ of full scale

REPEATABILITY: $\pm 1\%$

PRESSURE GAUGE: Glycerin dampened, 0 - 3,500 psi / 0 - 240 bar pressure range available on aluminum test kits.

Glycerin dampened, 0 - 6,000 psi / 0 - 400 bar pressure range available on stainless steel test kits.

LOAD VALVE: Produce ΔP up to 3,500 psi/241 bar PSID and 5,000 psi/345 bar PSID.

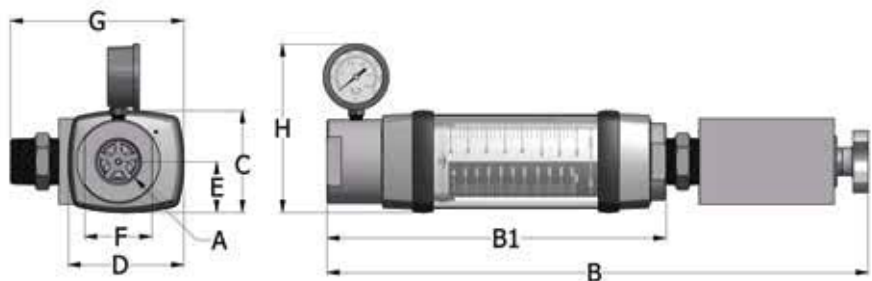

DIMENSIONS:

A	B	B ₁	C	D	E	F	G	H
NOMINAL PORT SIZE	LENGTH in (mm)	LENGTH in (mm)	WIDTH in (mm)	DEPTH in (mm)	OFFSET in (mm)	FLATS in (mm)	DEPTH in (mm)	WIDTH in (mm)
1-1/4	22.1 (561)	13.9 (353)	4.15 (105)	4.75 (121)	2.08 (53)	2.75 (70)	7.1 (180)	6.9 (175)
1-1/2	22.1 (561)	13.9 (353)	4.15 (105)	4.75 (121)	2.08 (53)	2.75 (70)	7.1 (180)	6.9 (175)

NOTE: Weights for all sizes can be found on page 79.

Pressures above 7500 PSI will pop the rupture disc allowing fluid flow to continue. This is a fail safe mechanism.

3500/5000 PSI Test Kits

For Water-based Fluids (Water/Oil Emulsions)

ORDERING INFORMATION:

NOMINAL PORT SIZE	FLOW RANGE		PRESSURE DROP			MODEL NUMBER (see example below)	MATERIAL		OPTIONS
	GPM	LPM	50% FLOW PSI (BAR)	100% FLOW PSI (BAR)	REVERSE 100% FLOW PSI (BAR)	NPT	ALUMINUM 3500 PSI	STAINLESS 5000 PSI	REVERSE FLOW
1 1/4"	3 - 30	10 - 110	3.4 (.23)	7.8 (.54)	5.6 (.39)	H TK 813 * - 030	A	S	RT
	5 - 50	20 - 190	4.3 (.30)	8.8 (6.1)	14.3 (.99)	H TK 813 * - 050			
	10 - 75	40 - 280	6.3 (.43)	14.3 (9.9)	35.7 (2.5)	H TK 813 * - 075			
	10 - 100	50 - 380	8.3 (.57)	21.3 (1.5)	45.3 (3.1)	H TK 813 * - 100			
	10 - 150	50 - 560	14.3 (.99)	41.3 (2.8)	124 (8.6)	H TK 813 * - 150			
1 1/2"	3 - 30	10 - 110	3.4 (.23)	7.8 (.54)	5.6 (.39)	H TK 883 * - 030	A	S	RT
	5 - 50	20 - 190	4.3 (.30)	8.8 (6.1)	14.3 (.99)	H TK 883 * - 050			
	10 - 75	40 - 280	6.3 (.43)	14.3 (9.9)	35.7 (2.5)	H TK 883 * - 075			
	10 - 100	50 - 380	8.3 (.57)	21.3 (1.5)	45.3 (3.1)	H TK 883 * - 100			
	10 - 150	50 - 560	14.3 (.99)	41.3 (2.8)	124 (8.6)	H TK 883 * - 150			

(example) H RT 813 A - 030

NOTE: TK suffix represents standard test kit configuration. For reverse flow by-pass test kit, replace TK suffix with RT suffix.

REVERSE FLOW BY-PASS OPTION: Features a two-piece cone that responds to flow in the primary flow direction in the same manner as the standard design. Flow in the reverse direction causes the lower cone shuttle to shift, moving it below the sharp-edged piston orifice. This shift creates a gap which allows the fluid to flow freely in the reverse direction.

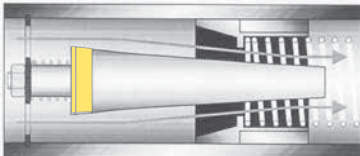

Normal Flow Direction

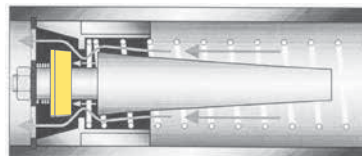

Reverse Flow By-Pass

CAUTION: For emulsions with less than 20% oil, factory recommends the Brass body meter.

3500/6000 PSI High Temperature

Flow Meters For Water-based Fluids (Water/Oil Emulsions)

- Direct reading
- Install in any position
- 360° rotatable guard/scale
- Easier-to-read linear scale
- No flow straighteners or special piping required
- Relatively insensitive to shock and vibration
- Good viscosity stability
- Temperature up to 500 °F
- Accuracy $\pm 2\%$ full scale
- Repeatability $\pm 1\%$
- Special scales available
- Calibrated for 1.0 S.G.
- For 80/20 and other water/oil emulsions



SPECIFICATIONS:

MATERIALS:

2024 - T351 Anodized aluminum body, piston and cone

C360 Brass body, piston and cone

T303 Stainless body, 2024 - T351 Anodized aluminum piston and cone

COMMON PARTS:

Spider Plate: T316 SS

Spring: T302 SS

Fasteners: T303 SS

Seals: Viton®

Scale Support: T316 SS

Scale: Polyimide

Retaining Ring: T316 SS

Retaining Spring: T316 SS

Indicator: Nickel-plated Carbon Steel

Internal Magnet: Teflon® Coated Alnico 8

Bumper: 2011 - T3 Anodized Aluminum

Guard: Cylindrical Pyrex® Glass

End Caps: 2011 - T3 Anodized Aluminum

THREADS: SAE J1926/1, NPTF ANSI B2.2, BSPP ISO1179, **Code 62:** SAE J518

TEMPERATURE RANGE: -20 to +400 °F (-29 to +205 °C) Continuous

+400 to +500 °F (+205 to +260 °C) Intermittent

For detailed "Pressure vs. Temperature" correlation information, see page 32.

PRESSURE RATING:

Aluminum / Brass Operating: 3,500 psi/241 bar max. with a 3:1 safety factor.

For High Cycle Applications: See page 7

Stainless Steel Operating: 6,000 psi/414 bar max. (5,000 psi/345 bar max.

for ¾" to 1½" series) with a 3:1 safety factor.

For High Cycle Applications: See page 7

PRESSURE DROP: See Ordering Information Table, page 32.

For detailed differential pressure charts, see page 63.

ACCURACY: $\pm 2\%$ of full scale

REPEATABILITY: $\pm 1\%$

REVERSE FLOW BY-PASS OPTION: Features a two-piece cone that responds to flow in the primary flow direction in the same manner as the standard design. Flow in the reverse direction causes the lower cone shuttle to shift, moving it below the sharp-edged piston orifice, which allows the fluid to flow freely in the reverse direction.

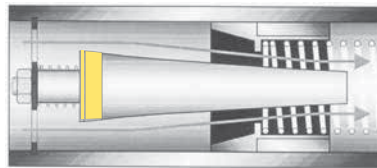

Normal Flow Direction

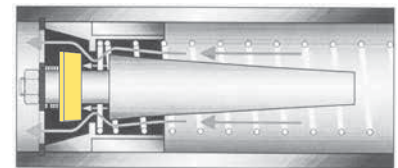

Reverse Flow By-Pass

DIMENSIONS:

A	B	C	D
NOMINAL PORT SIZE	LENGTH in (mm)	WIDTH in (mm)	FLATS in (mm)
¼ (SAE 6)	6.60 (168)	2.01 (53)	1.25 (32)
½ (SAE 10)	6.60 (168)	2.01 (53)	1.25 (32)
¾ (SAE 12)	7.20 (183)	2.48 (63)	1.50 (38)
1 (SAE 16)	7.20 (183)	2.48 (63)	1.75 (44)
1¼ (SAE 20)	12.20 (310)	4.20 (105)	2.75 (70)
1½ (SAE 24)	12.20 (310)	4.20 (105)	2.75 (70)

NOTE: Dimensions for 1½" Code 62 can be found on page 78.

Weights for all sizes can be found on page 79.



Pyrex is a registered trademark of Corning, Inc.

Teflon is a registered trademark of E.I. DuPont de Nemours & Co.

Viton is a registered trademark of DuPont Dow Elastomers

3500/6000 PSI High Temperature Flow Meters For Water-based Fluids (Water/Oil Emulsions)

ORDERING INFORMATION:

NOMINAL PORT SIZE ^①	FLOW RANGE		PRESSURE DROP			MODEL NUMBER (see example below)			MATERIAL			OPTIONS
	GPM	LPM	50% FLOW PSI (BAR)	100% FLOW PSI (BAR)	REVERSE 100% FLOW PSI (BAR)	SAE	NPTF	BSPP	ALUMINUM 3500 PSI	BRASS 3500 PSI	STAINLESS	REVERSE FLOW
¼" SAE 6	0.1 - 1.0	0.5 - 3.75	4.0 (.28)	9.0 (.62)		H212 * - 010 - HT	H213 * - 010 - HT	H214 * - 010 - HT	A	B	6000 PSI S	Not Available
	0.2 - 2.0	1.0 - 7.5	6.0 (.41)	13 (.90)		H212 * - 020 - HT	H213 * - 020 - HT	H214 * - 020 - HT				
½" SAE 10	0.1 - 1.0	0.5 - 3.75	2.0 (.14)	2.75 (.19)	5.2 (.36)	H612 * - 001 - HT	H613 * - 001 - HT	H614 * - 001 - HT	A	B	6000 PSI S	HR
	0.2 - 2.0	1 - 7.5	2.0 (.14)	3.0 (.21)	9.6 (.66)	H612 * - 002 - HT	H613 * - 002 - HT	H614 * - 002 - HT				
	0.5 - 5.0	2 - 19	3.0 (.21)	6.0 (.41)	4.8 (.33)	H612 * - 005 - HT	H613 * - 005 - HT	H614 * - 005 - HT				
	1 - 10	5 - 38	4.0 (.28)	9.5 (.66)	23.0 (1.6)	H612 * - 010 - HT	H613 * - 010 - HT	H614 * - 010 - HT				
	1 - 15	4 - 56	6.5 (.45)	18.5 (1.3)	55.2 (3.8)	H612 * - 015 - HT	H613 * - 015 - HT	H614 * - 015 - HT				
¾" SAE 12	0.2 - 2.0	1 - 7.5	1.0 (.07)	2.0 (.14)	2.9 (.20)	H712 * - 002 - HT	H713 * - 002 - HT	H714 * - 002 - HT	A	B	5000 PSI S	HR
	0.5 - 5.0	2 - 19	2.5 (.17)	3.5 (.24)	5.3 (.37)	H712 * - 005 - HT	H713 * - 005 - HT	H714 * - 005 - HT				
	1 - 10	5 - 38	3.5 (.24)	9.0 (.62)	8.8 (.61)	H712 * - 010 - HT	H713 * - 010 - HT	H714 * - 010 - HT				
	2 - 20	10 - 76	4.0 (.28)	9.0 (.62)	18.0 (1.24)	H712 * - 020 - HT	H713 * - 020 - HT	H714 * - 020 - HT				
	3 - 30	10 - 115	7.0 (.48)	16.5 (1.1)	45.1 (3.11)	H712 * - 030 - HT	H713 * - 030 - HT	H714 * - 030 - HT				
1" SAE 16	0.2 - 2.0	1 - 7.5	1.0 (.07)	2.0 (.14)	2.9 (.20)	H782 * - 002 - HT	H783 * - 002 - HT	H784 * - 002 - HT	A	B	5000 PSI S	HR
	0.5 - 5.0	2 - 19	2.5 (.17)	3.5 (.24)	5.3 (.37)	H782 * - 005 - HT	H783 * - 005 - HT	H784 * - 005 - HT				
	1 - 10	5 - 38	3.5 (.24)	9.0 (.62)	8.8 (.61)	H782 * - 010 - HT	H783 * - 010 - HT	H784 * - 010 - HT				
	2 - 20	10 - 76	4.0 (.28)	9.0 (.62)	18.0 (1.24)	H782 * - 020 - HT	H783 * - 020 - HT	H784 * - 020 - HT				
	3 - 30	10 - 115	7.0 (.48)	16.5 (1.1)	45.1 (3.11)	H782 * - 030 - HT	H783 * - 030 - HT	H784 * - 030 - HT				
	4 - 40	15 - 150	9.0 (.62)	24.0 (1.7)	87.5 (6.04)	H782 * - 040 - HT	H783 * - 040 - HT	H784 * - 040 - HT				
1¼" SAE 20	3 - 30	10 - 110	3.0 (.21)	4.0 (.28)	4.8 (.33)	H812 * - 030 - HT	H813 * - 030 - HT	H814 * - 030 - HT	A	B	5000 PSI S	HR
	5 - 50	20 - 190	3.5 (.24)	7.0 (.48)	12.5 (.86)	H812 * - 050 - HT	H813 * - 050 - HT	H814 * - 050 - HT				
	10 - 75	40 - 280	5.0 (.35)	10.5 (.72)	31.9 (2.2)	H812 * - 075 - HT	H813 * - 075 - HT	H814 * - 075 - HT				
	10 - 100	50 - 380	6.5 (.45)	15.0 (1.0)	39.0 (2.7)	H812 * - 100 - HT	H813 * - 100 - HT	H814 * - 100 - HT				
	10 - 150	50 - 560	10.5 (.72)	27.5 (1.9)	110 (7.6)	H812 * - 150 - HT	H813 * - 150 - HT	H814 * - 150 - HT				
1½" SAE 24	3 - 30	10 - 110	3.0 (.21)	4.0 (.28)	4.8 (.33)	H882 * - 030 - HT	H883 * - 030 - HT	H884 * - 030 - HT	A	B	5000 PSI S	HR
	5 - 50	20 - 190	3.5 (.24)	7.0 (.48)	12.5 (.86)	H882 * - 050 - HT	H883 * - 050 - HT	H884 * - 050 - HT				
	10 - 75	40 - 280	5.0 (.35)	10.5 (.72)	31.9 (2.2)	H882 * - 075 - HT	H883 * - 075 - HT	H884 * - 075 - HT				
	10 - 100	50 - 380	6.5 (.45)	15.0 (1.0)	39.0 (2.7)	H882 * - 100 - HT	H883 * - 100 - HT	H884 * - 100 - HT				
	10 - 150	50 - 560	10.5 (.72)	27.5 (1.9)	110 (7.6)	H882 * - 150 - HT	H883 * - 150 - HT	H884 * - 150 - HT				
1½" Code 62	3 - 30	10 - 110	3.0 (.21)	4.0 (.28)	4.8 (.33)	H818 * - 030 - HT			A	B	4000 PSI S	HR
	5 - 50	20 - 190	3.5 (.24)	7.0 (.48)	12.5 (.86)	H818 * - 050 - HT						
	10 - 75	40 - 280	5.0 (.35)	10.5 (.72)	31.9 (2.2)	H818 * - 075 - HT						
	10 - 100	50 - 380	6.5 (.45)	15.0 (1.0)	39.0 (2.7)	H818 * - 100 - HT						
	10 - 150	50 - 560	10.5 (.72)	27.5 (1.9)	110 (7.6)	H818 * - 150 - HT						

①Fractional sizes apply to NPTF and BSPP.

(example) H 713 A - 030 - HR

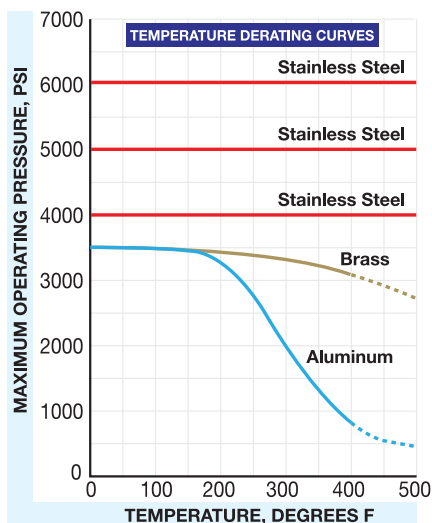
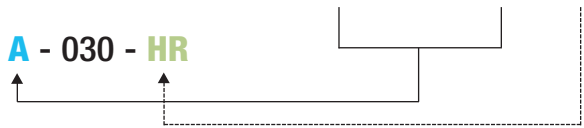

NOTE: HT suffix represents standard high temperature configuration. For reverse flow high temperature, replace HT with HR suffix.

NOTE: HR option is not available with brass flow meters.

— CONTINUOUS TEMPERATURE
 - - - - - INTERMITTENT TEMPERATURE

CAUTION: For emulsions with less than 20% oil, factory recommends the Brass body meter.

3500/6000 PSI Flow Meters

For Water and Other Liquids

- Direct reading
- Install in any position
- 360° rotatable guard/scale
- Easier-to-read linear scale
- No flow straighteners or special piping required
- Relatively insensitive to shock and vibration
- Good viscosity stability
- Temperature up to 240 °F
- Accuracy $\pm 2\%$ full scale
- Repeatability $\pm 1\%$
- Special scales available
- Calibrated for 1.0 S.G.



SPECIFICATIONS:

MATERIALS:

C360 Brass body, piston and cone[Ⓟ]

T303 Stainless body, C360 Brass piston and cone

COMMON PARTS:

Spider Plate: T316 SS

Spring: T302 SS

Fasteners: T303 SS

Pressure Seals: Viton[®]

Guard: Polycarbonate

Retaining Ring: T316 SS

Retaining Spring: T316 SS

Indicator and Internal Magnet: PPS / Ceramic

Guard Seal / Bumper: Buna N

Scale Support: 6063 - T6 Aluminum

End Caps: Nylon ST

THREADS: SAE J1926/1, NPTF ANSI B2.2, BSPP ISO1179

TEMPERATURE RANGE: -20 to +240 °F (-29 to +116 °C) for higher temp. meters, see page 35.

PRESSURE RATING:

Brass Operating: 3,500 psi/241 bar max. (800 psi/55 bar max. for 3" series) with a 3:1 safety factor.

For High Cycle Applications: See page 7

Stainless Steel Operating: 6,000 psi/414 bar max. (5,000 psi/345 bar max. for ¾" to 1½" series) with a 3:1 safety factor.

For High Cycle Applications: See page 7

PRESSURE DROP: See Ordering Information Table, page 34.

For detailed differential pressure charts, see page 64.

ACCURACY: $\pm 2\%$ of full scale, $\pm 7\%$ of full scale for ¼" meters **REPEATABILITY:** $\pm 1\%$

DIMENSIONS:

A	B	C	D	E	F
NOMINAL PORT SIZE	LENGTH in (mm)	WIDTH in (mm)	DEPTH in (mm)	OFFSET in (mm)	FLATS in (mm)
¼ (SAE 6)	4.8 (122)	1.68 (43)	1.90 (48)	.84 (21)	.88 (22)
½ (SAE 10)	6.6 (168)	2.07 (53)	2.40 (61)	1.04 (26)	1.25 (32)
¾ (SAE 12)	7.2 (183)	2.48 (63)	2.85 (72)	1.24 (32)	1.50 (38)
1 (SAE 16)	7.2 (183)	2.48 (63)	2.85 (72)	1.24 (32)	1.75 (44)
1¼ (SAE 20)	12.2 (310)	4.12 (105)	4.72 (120)	2.06 (52)	2.75 (70)
1½ (SAE 24)	12.2 (310)	4.12 (105)	4.72 (120)	2.06 (52)	2.75 (70)

NOTE: Dimensions for 3" can be found on page 78.

Weights for all sizes can be found on page 79.

[Ⓟ]3 inch models have Celcon[®] piston/piston ring

Celcon is a registered trademark of Hoechst Celanese Corp.

Viton is a registered trademark of DuPont Dow Elastomers

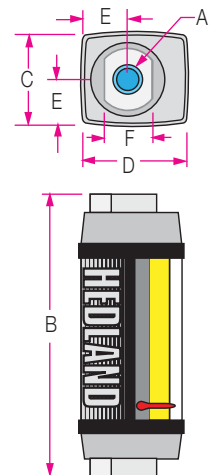

3500/6000 PSI Flow Meters

For Water and Other Liquids

ORDERING INFORMATION:

NOMINAL PORT SIZE ^②	FLOW RANGE		PRESSURE DROP		MODEL NUMBER (see example below)			MATERIAL	
	GPM	LPM	50% FLOW PSI (BAR)	100% FLOW PSI (BAR)	SAE	NPTF	BSPP ^③	BRASS 3500 PSI	STAINLESS
¼" SAE 6	.02 - 0.2	0.1 - 0.75	3.5 (.24)	4.0 (.28)	H204 * - 002	H205 * - 002	H206 * - 002	B	6000 PSI S
	.05 - 0.5	0.2 - 1.9	3.0 (.21)	5.0 (.35)	H204 * - 005	H205 * - 005	H206 * - 005		
	0.1 - 1.0	0.5 - 3.75	4.0 (.28)	9.0 (.62)	H204 * - 010	H205 * - 010	H206 * - 010		
	0.2 - 2.0	1 - 7.5	6.0 (.41)	13 (.90)	H204 * - 020	H205 * - 020	H206 * - 020		
½" SAE 10	0.1 - 1.0	0.5 - 3.75	2.0 (.14)	2.75 (.19)	H604 * - 001	H605 * - 001	H606 * - 001	B	6000 PSI S
	0.2 - 2.0	1 - 7.5	2.0 (.14)	3.0 (.21)	H604 * - 002	H605 * - 002	H606 * - 002		
	0.5 - 5.0	2 - 19	3.0 (.21)	6.0 (.41)	H604 * - 005	H605 * - 005	H606 * - 005		
	1 - 10	5 - 38	4.0 (.28)	9.5 (.66)	H604 * - 010	H605 * - 010	H606 * - 010		
	1 - 15	4 - 56	6.5 (.45)	18.5 (1.3)	H604 * - 015	H605 * - 015	H606 * - 015		
¾" SAE 12	0.2 - 2.0	1 - 7.5	1.0 (.07)	2.0 (.14)	H704 * - 002	H705 * - 002	H706 * - 002	B	5000 PSI S
	0.5 - 5.0	2 - 19	2.5 (.17)	3.5 (.24)	H704 * - 005	H705 * - 005	H706 * - 005		
	1 - 10	5 - 38	3.5 (.24)	9.0 (.62)	H704 * - 010	H705 * - 010	H706 * - 010		
	2 - 20	10 - 76	4.0 (.28)	9.0 (.62)	H704 * - 020	H705 * - 020	H706 * - 020		
	3 - 30	10 - 115	7.0 (.48)	16.5 (1.1)	H704 * - 030	H705 * - 030	H706 * - 030		
1" SAE 16	0.2 - 2.0	1 - 7.5	1.0 (.07)	2.0 (.14)	H754 * - 002	H755 * - 002	H756 * - 002	B	5000 PSI S
	0.5 - 5.0	2 - 19	2.5 (.17)	3.5 (.24)	H754 * - 005	H755 * - 005	H756 * - 005		
	1 - 10	5 - 38	3.5 (.24)	9.0 (.62)	H754 * - 010	H755 * - 010	H756 * - 010		
	2 - 20	10 - 76	4.0 (.28)	9.0 (.62)	H754 * - 020	H755 * - 020	H756 * - 020		
	3 - 30	10 - 115	7.0 (.48)	16.5 (1.1)	H754 * - 030	H755 * - 030	H756 * - 030		
	4 - 40	15 - 150	9.0 (.62)	24 (1.7)	H754 * - 040	H755 * - 040	H756 * - 040		
1¼" SAE 20	3 - 30	10 - 110	3.0 (.21)	4.0 (.28)	H804 * - 030	H805 * - 030	H806 * - 030	B	5000 PSI S
	5 - 50	20 - 190	3.5 (.24)	7.0 (.48)	H804 * - 050	H805 * - 050	H806 * - 050		
	10 - 75	40 - 280	5.0 (.35)	10.5 (.72)	H804 * - 075	H805 * - 075	H806 * - 075		
	10 - 100	50 - 380	6.5 (.45)	15.0 (1.0)	H804 * - 100	H805 * - 100	H806 * - 100		
	10 - 150	50 - 560	10.5 (.72)	27.5 (1.9)	H804 * - 150	H805 * - 150	H806 * - 150		
1½" SAE 24	3 - 30	10 - 110	3.0 (.21)	4.0 (.28)	H854 * - 030	H855 * - 030	H856 * - 030	B	5000 PSI S
	5 - 50	20 - 190	3.5 (.24)	7.0 (.48)	H854 * - 050	H855 * - 050	H856 * - 050		
	10 - 75	40 - 280	5.0 (.35)	10.5 (.72)	H854 * - 075	H855 * - 075	H856 * - 075		
	10 - 100	50 - 380	6.5 (.45)	15.0 (1.0)	H854 * - 100	H855 * - 100	H856 * - 100		
	10 - 150	50 - 560	10.5 (.72)	27.5 (1.9)	H854 * - 150	H855 * - 150	H856 * - 150		
3"	5 - 50	20 - 190	.50 (.03)	.75 (.05)	Not Available	H905 B - 050	H906 B - 050	B	800 PSI Not Available
	10 - 100	40 - 360	1.40 (.10)	2.25 (1.6)		H905 B - 100	H906 B - 100		
	30 - 150	125 - 575	3.25 (.22)	5.25 (.36)		H905 B - 150	H906 B - 150		
	20 - 275	100 - 1000	11.0 (.76)	18 (1.2)		H905 B - 275	H906 B - 275		

②Fractional sizes apply to NPTF and BSPP.

③3 inch models have BSPT (BS21) threads

(example) H 705 **B** - 030

3500/6000 PSI High Temperature

Flow Meters For Water and Other Liquids

- Direct reading
- Install in any position
- 360° rotatable guard/scale
- Easier-to-read linear scale
- No flow straighteners or special piping required
- Relatively insensitive to shock and vibration
- Good viscosity stability
- Temperature up to 500 °F
- Accuracy $\pm 2\%$ full scale
- Repeatability $\pm 1\%$
- Special scales available
- Calibrated for 1.0 S.G.

SPECIFICATIONS:

MATERIALS:

C360 Brass body, piston and cone

T303 Stainless body, C360 Brass piston and cone

COMMON PARTS:

Spider Plate: T316 SS

Spring: T302 SS

Fasteners: T303 SS

Seals: Viton®

Scale Support: T316 SS

Scale: Polyimide

Retaining Ring: T316 SS

Retaining Spring: T316 SS

Indicator: Nickel-plated Carbon Steel

Internal Magnet: Teflon® Coated Alnico 8

Bumper: 2011 - T3 Anodized Aluminum

Guard: Cylindrical Pyrex® Glass

End Caps: 2011 - T3 Anodized Aluminum

THREADS: SAE J1926/1, NPTF ANSI B2.2, BSPP ISO1179

TEMPERATURE RANGE: -20 to +400 °F (-29 to +205 °C) Continuous

+400 to +500 °F (+205 to +260 °C) Intermittent

For detailed "Pressure vs. Temperature" correlation information, see page 36.

PRESSURE RATING:

Brass Operating: 3,500 psi/241 bar max. with a 3:1 safety factor.

For High Cycle Applications: See page 7

Stainless Steel Operating: 6,000 psi/414 bar max. (5,000 psi/345 bar max.

for ¾" to 1½" series) with a 3:1 safety factor.

For High Cycle Applications: See page 7

PRESSURE DROP: See Ordering Information Table, page 36.

For detailed differential pressure charts, see page 64.

ACCURACY: $\pm 2\%$ of full scale

REPEATABILITY: $\pm 1\%$



DIMENSIONS:

A	B	C	D
NOMINAL PORT SIZE	LENGTH in (mm)	WIDTH in (mm)	FLATS in (mm)
¼ (SAE 6)	6.60 (168)	2.01 (53)	1.25 (32)
½ (SAE 10)	6.60 (168)	2.01 (53)	1.25 (32)
¾ (SAE 12)	7.20 (183)	2.48 (63)	1.50 (38)
1 (SAE 16)	7.20 (183)	2.48 (63)	1.75 (44)
1¼ (SAE 20)	12.20 (310)	4.20 (105)	2.75 (70)
1½ (SAE 24)	12.20 (310)	4.20 (105)	2.75 (70)

NOTE: Weights for all sizes can be found on page 79.

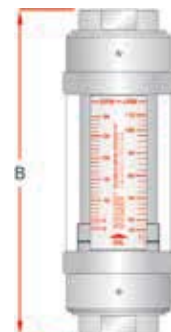

Pyrex is a registered trademark of Corning, Inc.

Teflon is a registered trademark of E.I. DuPont de Nemours & Co.

Viton is a registered trademark of DuPont Dow Elastomers

3500/6000 PSI High Temperature Flow Meters For Water and Other Liquids

ORDERING INFORMATION:

NOMINAL PORT SIZE [Ⓢ]	FLOW RANGE		PRESSURE DROP		MODEL NUMBER (see example below)			MATERIAL	
	GPM	LPM	50% FLOW PSI (BAR)	100% FLOW PSI (BAR)	SAE	NPTF	BSPP [Ⓢ]	BRASS 3500 PSI	STAINLESS
¼" SAE 6	0.1 - 1.0	0.5 - 3.75	4.0 (.28)	9.0 (.62)	H204 * - 010 - HT	H205 * - 010 - HT	H206 * - 010 - HT	B	6000 PSI S
	0.2 - 2.0	1 - 7.5	6.0 (.41)	13.0 (.90)	H204 * - 020 - HT	H205 * - 020 - HT	H206 * - 020 - HT		
½" SAE 10	0.1 - 1.0	0.5 - 3.75	2.0 (.14)	2.75 (.19)	H604 * - 001 - HT	H605 * - 001 - HT	H606 * - 001 - HT	B	6000 PSI S
	0.2 - 2.0	1 - 7.5	2.0 (.14)	3.0 (.21)	H604 * - 002 - HT	H605 * - 002 - HT	H606 * - 002 - HT		
	0.5 - 5.0	2 - 19	3.0 (.21)	6.0 (.41)	H604 * - 005 - HT	H605 * - 005 - HT	H606 * - 005 - HT		
	1 - 10	5 - 38	4.0 (.28)	9.5 (.66)	H604 * - 010 - HT	H605 * - 010 - HT	H606 * - 010 - HT		
	2 - 10	10 - 76	4.0 (.28)	9.0 (.62)	H704 * - 020 - HT	H705 * - 020 - HT	H706 * - 020 - HT		
	1 - 15	4 - 56	6.5 (.45)	18.5 (1.3)	H604 * - 015 - HT	H605 * - 015 - HT	H606 * - 015 - HT		
¾" SAE 12	0.2 - 2.0	1 - 7.5	1.0 (.07)	2.0 (.14)	H704 * - 002 - HT	H705 * - 002 - HT	H706 * - 002 - HT	B	5000 PSI S
	0.5 - 5.0	2 - 19	2.5 (.17)	3.5 (.24)	H704 * - 005 - HT	H705 * - 005 - HT	H706 * - 005 - HT		
	1 - 10	5 - 38	3.5 (.24)	9.0 (.62)	H704 * - 010 - HT	H705 * - 010 - HT	H706 * - 010 - HT		
	2 - 20	10 - 76	4.0 (.28)	9.0 (.62)	H704 * - 020 - HT	H705 * - 020 - HT	H706 * - 020 - HT		
	3 - 30	10 - 115	7.0 (.48)	16.5 (1.1)	H704 * - 030 - HT	H705 * - 030 - HT	H706 * - 030 - HT		
1" SAE 16	0.2 - 2.0	1 - 7.5	1.0 (.07)	2.0 (.14)	H754 * - 002 - HT	H755 * - 002 - HT	H756 * - 002 - HT	B	5000 PSI S
	0.5 - 5.0	2 - 19	2.5 (.17)	3.5 (.24)	H754 * - 005 - HT	H755 * - 005 - HT	H756 * - 005 - HT		
	1 - 10	5 - 38	3.5 (.24)	9.0 (.62)	H754 * - 010 - HT	H755 * - 010 - HT	H756 * - 010 - HT		
	2 - 20	10 - 76	4.0 (.28)	9.0 (.62)	H754 * - 020 - HT	H755 * - 020 - HT	H756 * - 020 - HT		
	3 - 30	10 - 115	7.0 (.48)	16.5 (1.1)	H754 * - 030 - HT	H755 * - 030 - HT	H756 * - 030 - HT		
	4 - 40	15 - 150	9.0 (.62)	24.0 (1.7)	H754 * - 040 - HT	H755 * - 040 - HT	H756 * - 040 - HT		
	5 - 50	20 - 190	12.5 (.86)	34.0 (2.3)	H754 * - 050 - HT	H755 * - 050 - HT	H756 * - 050 - HT		
1¼" SAE 20	3 - 30	10 - 110	3.0 (.21)	4.0 (.28)	H804 * - 030 - HT	H805 * - 030 - HT	H806 * - 030 - HT	B	5000 PSI S
	5 - 50	20 - 190	3.5 (.24)	7.0 (.48)	H804 * - 050 - HT	H805 * - 050 - HT	H806 * - 050 - HT		
	10 - 75	40 - 280	5.0 (.35)	10.5 (.72)	H804 * - 075 - HT	H805 * - 075 - HT	H806 * - 075 - HT		
	10 - 100	50 - 380	6.5 (.45)	15.0 (1.0)	H804 * - 100 - HT	H805 * - 100 - HT	H806 * - 100 - HT		
	10 - 150	50 - 560	10.5 (.72)	27.5 (1.9)	H804 * - 150 - HT	H805 * - 150 - HT	H806 * - 150 - HT		
1½" SAE 24	3 - 30	10 - 110	3.0 (.21)	4.0 (.28)	H854 * - 030 - HT	H855 * - 030 - HT	H856 * - 030 - HT	B	5000 PSI S
	5 - 50	20 - 190	3.5 (.24)	7.0 (.48)	H854 * - 050 - HT	H855 * - 050 - HT	H856 * - 050 - HT		
	10 - 75	40 - 280	5.0 (.35)	10.5 (.72)	H854 * - 075 - HT	H855 * - 075 - HT	H856 * - 075 - HT		
	10 - 100	50 - 380	6.5 (.45)	15.0 (1.0)	H854 * - 100 - HT	H855 * - 100 - HT	H856 * - 100 - HT		
	10 - 150	50 - 560	10.5 (.72)	27.5 (1.9)	H854 * - 150 - HT	H855 * - 150 - HT	H856 * - 150 - HT		

Ⓢ Fractional sizes apply to NPTF and BSPP.

(example) H 705 **B** - 030 - HT

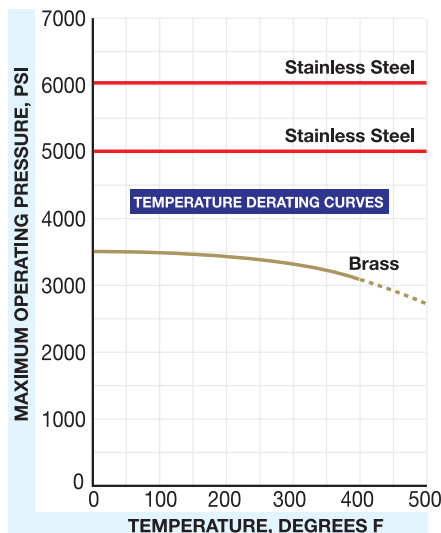

NOTE: HT suffix represents standard high temperature configuration.

6000 PSI Flow Meters

For A.P.I. Oil / Caustic and Corrosive Liquids

- Direct reading
- Install in any position
- 360° rotatable guard/scale
- Easier-to-read linear scale
- No flow straighteners or special piping required
- Relatively insensitive to shock and vibration
- Good viscosity stability
- Temperature up to 240 °F
- Accuracy $\pm 2\%$ full scale
- Repeatability $\pm 1\%$
- Special scales available

SPECIFICATIONS:

MATERIALS:

T316 Stainless body, piston and cone

COMMON PARTS: Retaining Ring: T316 SS
 Spider Plate: T316 SS Retaining Spring: T316 SS
 Spring: T316 SS Indicator and Internal Magnet: PPS / Ceramic
 Fasteners: T316 SS Guard Seal / Bumper: Buna N
 Pressure Seals: Viton® Scale Support: 6063 - T6 Aluminum
 Guard: Polycarbonate End Caps: Nylon ST

THREADS: NPTF ANSI B2.2, BSPP ISO1179

TEMPERATURE RANGE: -20 to +240 °F (-29 to +116 °C) for higher temperatures consult factory

PRESSURE RATING:

Oil / Liquids Operating: 6,000 psi/414 bar max. (5,000 psi/345 bar max. for ¾" to 1½" Series) with a 3:1 safety factor.

For High Cycle Applications: See page 7

PRESSURE DROP: See Ordering Information Table, page 38.

For detailed differential pressure charts, see page 65 for API Oil, and page 64 for Liquids.

ACCURACY: $\pm 2\%$ of full scale, $\pm 7\%$ of full scale for ¼" meters **REPEATABILITY:** $\pm 1\%$

HOSTILE ENVIRONMENT OPTION SPECIFICATIONS:

MATERIALS:

T316 Stainless body, piston and cone

COMMON PARTS: Retaining Ring: T316 SS
 Spider Plate: T316 SS Retaining Spring: T316 SS
 Spring: T316 SS Indicator: T416 SS
 Fasteners: T316 SS Bumper: T316 SS
 Seals: Viton® Scale Support: T316 SS
 End Caps: T316 SS Guard: Cylindrical Pyrex® glass
 Internal Magnet: Teflon® Coated Alnico 8

TEMPERATURE RANGE: -20 to +400 °F (-29 to +205 °C) Continuous

+400 to +500 °F (+205 to +260 °C) Intermittent

For detailed "Pressure vs. Temperature" correlation information, see page 38.

NOTE: See page 35 for dimensions and similar photo illustration.



DIMENSIONS:

	A	B	C	D	E	F
NOMINAL PORT SIZE	LENGTH in (mm)	WIDTH in (mm)	DEPTH in (mm)	OFFSET in (mm)	FLATS in (mm)	
¼	4.8 (122)	1.68 (43)	1.90 (48)	.84 (21)	.88 (22)	
½	6.6 (168)	2.07 (53)	2.40 (61)	1.04 (26)	1.25 (32)	
¾	7.2 (183)	2.48 (63)	2.85 (72)	1.24 (32)	1.50 (38)	
1	7.2 (183)	2.48 (63)	2.85 (72)	1.24 (32)	1.75 (44)	
1¼	12.2 (310)	4.12 (105)	4.72 (120)	2.06 (52)	2.75 (70)	
1½	12.2 (310)	4.12 (105)	4.72 (120)	2.06 (52)	2.75 (70)	

NOTE: Weights for all sizes can be found on page 79.

Pyrex is a registered trademark of Corning, Inc.
 Teflon is a registered trademark of E.I. DuPont de Nemours & Co.
 Viton is a registered trademark of DuPont Dow Elastomers

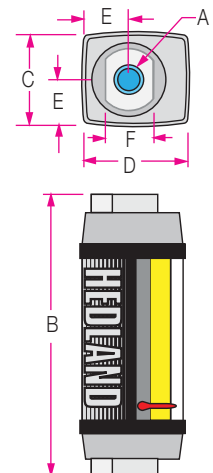

6000 PSI Flow Meters

For A.P.I. Oil / Caustic and Corrosive Liquids

ORDERING INFORMATION:

NOMINAL PORT SIZE	FLOW RANGE		PRESSURE DROP		MODEL NUMBER (see example below)				HOSTILE ENVIRONMENT OPTION
	GPM	LPM	50% FLOW PSI (BAR)	100% FLOW PSI (BAR)	API - OIL .876 (S.G.)		LIQUIDS 1.0 (S.G.)		
					NPTF	BSPP	NPSF	BSPP	
¼"	0.1 - 1.0	0.5 - 3.75	4.0 (.28)	9.0 (.62)	6000 PSI		6000 PSI		HE
	0.2 - 2.0	1 - 7.5	6.0 (.41)	13.0 (.90)	H231X - 010 - † H231X - 020 - †	H232X - 010 - † H232X - 020 - †	H234X - 010 - † H234X - 020 - †	H235X - 010 - † H235X - 020 - †	
½"	0.2 - 2.0	1 - 7.5	2.0 (.14)	3.0 (.21)	6000 PSI		6000 PSI		HE
	0.5 - 5.0	2 - 19	3.0 (.21)	6.0 (.41)	H631X - 002 - † H631X - 005 - †	H632X - 002 - † H632X - 005 - †	H634X - 002 - † H634X - 005 - †	H635X - 002 - † H635X - 005 - †	
	1 - 10	5 - 38	4.0 (.28)	9.5 (.66)	H631X - 010 - †	H632X - 010 - †	H634X - 010 - †	H635X - 010 - †	
	1 - 15	4 - 56	6.5 (.45)	18.5 (1.3)	H631X - 015 - †	H632X - 015 - †	H634X - 015 - †	H635X - 015 - †	
¾"	0.2 - 2.0	1 - 7.5	1.0 (.07)	2.0 (.14)	5000 PSI		5000 PSI		HE
	0.5 - 5.0	2 - 19	2.5 (.17)	3.5 (.24)	H731X - 002 - † H731X - 005 - †	H732X - 002 - † H732X - 005 - †	H734X - 002 - † H734X - 005 - †	H735X - 002 - † H735X - 005 - †	
	1 - 10	5 - 38	3.5 (.24)	9.0 (.62)	H731X - 010 - †	H732X - 010 - †	H734X - 010 - †	H735X - 010 - †	
	2 - 20	10 - 76	4.0 (.28)	9.0 (.62)	H731X - 020 - †	H732X - 020 - †	H734X - 020 - †	H735X - 020 - †	
	3 - 30	10 - 115	7.0 (.48)	16.5 (1.1)	H731X - 030 - †	H732X - 030 - †	H734X - 030 - †	H735X - 030 - †	
1"	0.2 - 2.0	1 - 7.5	1.0 (.07)	2.0 (.14)	5000 PSI		5000 PSI		HE
	0.5 - 5.0	2 - 19	2.5 (.17)	3.5 (.24)	H741X - 002 - † H741X - 005 - †	H742X - 002 - † H742X - 005 - †	H744X - 002 - † H744X - 005 - †	H745X - 002 - † H745X - 005 - †	
	1 - 10	5 - 38	3.5 (.24)	9.0 (.62)	H741X - 010 - †	H742X - 010 - †	H744X - 010 - †	H745X - 010 - †	
	2 - 20	10 - 76	4.0 (.28)	9.0 (.62)	H741X - 020 - †	H742X - 020 - †	H744X - 020 - †	H745X - 020 - †	
	3 - 30	10 - 115	7.0 (.48)	16.5 (1.1)	H741X - 030 - †	H742X - 030 - †	H744X - 030 - †	H745X - 030 - †	
1¼"	3 - 30	10 - 110	3.0 (.21)	4.0 (.28)	5000 PSI		5000 PSI		HE
	5 - 50	20 - 190	3.5 (.24)	7.0 (.48)	H831X - 030 - † H831X - 050 - †	H832X - 030 - † H832X - 050 - †	H834X - 030 - † H834X - 050 - †	H835X - 030 - † H835X - 050 - †	
	10 - 75	40 - 280	5.0 (.35)	10.5 (.72)	H831X - 075 - †	H832X - 075 - †	H834X - 075 - †	H835X - 075 - †	
	10 - 100	50 - 380	6.5 (.45)	15.0 (1.0)	H831X - 100 - †	H832X - 100 - †	H834X - 100 - †	H835X - 100 - †	
1½"	3 - 30	10 - 110	3.0 (.21)	4.0 (.28)	5000 PSI		5000 PSI		HE
	5 - 50	20 - 190	3.5 (.24)	7.0 (.48)	H841X - 030 - † H841X - 050 - †	H842X - 030 - † H842X - 050 - †	H844X - 030 - † H844X - 050 - †	H845X - 030 - † H845X - 050 - †	
	10 - 75	40 - 280	5.0 (.35)	10.5 (.72)	H841X - 075 - †	H842X - 075 - †	H844X - 075 - †	H845X - 075 - †	
	10 - 100	50 - 380	6.5 (.45)	15.0 (1.0)	H841X - 100 - †	H842X - 100 - †	H844X - 100 - †	H845X - 100 - †	

NOTE: Consult factory for availability.

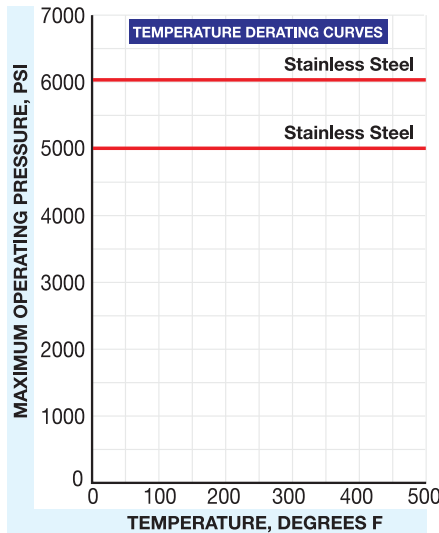

(example) H731X - 030 - HE

1500 PSI Flow Meters

For Air / Caustic and Corrosive Gases

- Direct reading
- Install in any position
- 360° rotatable guard/scale
- Easier-to-read linear scale
- No flow straighteners or special piping required
- Relatively insensitive to shock and vibration
- Temperature up to 240 °F
- Accuracy $\pm 2\%$ full scale
- Repeatability $\pm 1\%$
- Special scales available

SPECIFICATIONS:

MATERIALS:

T316 Stainless body, piston and cone

COMMON PARTS: Retaining Ring: T316 SS
 Spider Plate: T316 SS Retaining Spring: T316 SS
 Spring: T316 SS Indicator and Internal Magnet: PPS / Ceramic
 Fasteners: T316 SS Guard Seal/Bumper: Buna N
 Pressure Seals: Viton® Scale Support: 6063 - T6 Aluminum
 Guard: Polycarbonate End Caps: Nylon ST

THREADS: NPTF ANSI B2.2, BSPP ISO1179

TEMPERATURE RANGE: -20 to +240 °F (-29 to +116 °C) for higher temperatures consult factory

PRESSURE RATING:

Air / Gases Operating: 1,500 psi/103 bar max. with a 10:1 safety factor.

For High Cycle Applications: See page 7

PRESSURE DROP: See Ordering Information Table, page 40.

For detailed differential pressure charts, see page 65.

ACCURACY: $\pm 2\%$ of full scale, $\pm 7\%$ of full scale for 1/4" meters **REPEATABILITY:** $\pm 1\%$

HOSTILE ENVIRONMENT OPTION SPECIFICATIONS:

MATERIALS:

T316 Stainless body, piston and cone

COMMON PARTS: Retaining Ring: T316 SS
 Spider Plate: T316 SS Retaining Spring: T316 SS
 Spring: T316 SS Indicator: T416 SS
 Fasteners: T316 SS Bumper: T316 SS
 Seals: Viton® Scale Support: T316 SS
 End Caps: T316 SS Guard: Cylindrical Pyrex® glass
 Internal Magnet: Teflon® Coated Alnico 8

TEMPERATURE RANGE: -20 to +400 °F (-29 to +205 °C) Continuous

+400 to +500 °F (+205 to +260 °C) Intermittent

For detailed "Pressure vs. Temperature" correlation information, see page 40.

NOTE: See page 29 for dimensions and similar photo illustration.



DIMENSIONS:

	A	B	C	D	E	F
NOMINAL PORT SIZE	LENGTH in (mm)	WIDTH in (mm)	DEPTH in (mm)	OFFSET in (mm)	FLATS in (mm)	
1/4	4.8 (122)	1.68 (43)	1.90 (48)	.84 (21)	.88 (22)	
1/2	6.6 (168)	2.07 (53)	2.40 (61)	1.04 (26)	1.25 (32)	
3/4	7.2 (183)	2.48 (63)	2.85 (72)	1.24 (32)	1.50 (38)	
1	7.2 (183)	2.48 (63)	2.85 (72)	1.24 (32)	1.75 (44)	
1 1/4	12.2 (310)	4.12 (105)	4.72 (120)	2.06 (52)	2.75 (70)	
1 1/2	12.2 (310)	4.12 (105)	4.72 (120)	2.06 (52)	2.75 (70)	

NOTE: Weights for all sizes can be found on page 79.

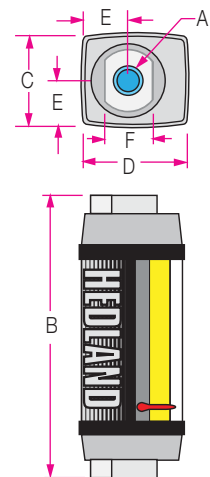

Pyrex is a registered trademark of Corning, Inc.
 Teflon is a registered trademark of E.I. DuPont de Nemours & Co.
 Viton is a registered trademark of DuPont Dow Elastomers

1500 PSI Flow Meters

For Air / Caustic and Corrosive Gases

ORDERING INFORMATION:

NOMINAL PORT SIZE	FLOW RANGE		PRESSURE DROP		MODEL NUMBER (see example below)		HOSTILE ENVIRONMENT OPTION
	① SCFM	② L/SEC	50% FLOW PSI (BAR)	100% FLOW PSI (BAR)	GASES 1.0 (S.G.)		
					NPTF	BSPB	
1/4"	2-20	1-9	10.15 (0.70)	18.71 (1.29)	H237X - 020 - †	H238X - 020 - †	Not Available
	3-30	1.5-14	13.75 (0.95)	26.23 (1.81)	H237X - 030 - †	H238X - 030 - †	
1/2"	3-25	2-12	3.73 (0.26)	6.10 (0.42)	H637X - 025 - †	H638X - 025 - †	HE
	5-50	3-22	6.04 (0.42)	10.35 (0.71)	H637X - 050 - †	H638X - 050 - †	
	10-100	5-47	7.18 (0.50)	13.85 (0.95)	H637X - 100 - †	H638X - 100 - †	
	15-150	7-70	8.06 (0.56)	18.49 (1.27)	H637X - 150 - †	H638X - 150 - †	
3/4"	3-25	1.5-11.5	2.99 (0.21)	5.90 (0.41)	H737X - 025 - †	H738X - 025 - †	HE
	5-50	2-23	2.00 (0.14)	3.58 (0.25)	H737X - 050 - †	H738X - 050 - †	
	10-100	5-47.5	7.19 (0.50)	12.87 (0.89)	H737X - 100 - †	H738X - 100 - †	
	15-150	7-70	4.44 (0.31)	9.52 (0.66)	H737X - 150 - †	H738X - 150 - †	
1"	3-25	1.5-11.5	2.99 (0.21)	5.90 (0.41)	H747X - 025 - †	H748X - 025 - †	HE
	5-50	2-23	2.00 (0.14)	3.58 (0.25)	H747X - 050 - †	H748X - 050 - †	
	10-100	5-47.5	7.19 (0.50)	12.87 (0.89)	H747X - 100 - †	H748X - 100 - †	
	15-150	7-70	4.44 (0.31)	9.52 (0.66)	H747X - 150 - †	H748X - 150 - †	
1 1/4"	20-200	10-95	1.89 (0.13)	3.16 (0.22)	H837X - 200 - †	H838X - 200 - †	HE
	40-400	20-180	2.53 (0.17)	5.49 (0.38)	H837X - 400 - †	H838X - 400 - †	
	60-600	30-280	4.47 (0.31)	10.71 (0.74)	H837X - 600 - †	H838X - 600 - †	
	80-800	50-350	6.13 (0.42)	17.14 (1.18)	H837X - 800 - †	H838X - 800 - †	
1 1/2"	20-200	10-95	1.89 (0.13)	3.16 (0.22)	H847X - 200 - †	H848X - 200 - †	HE
	40-400	20-180	2.53 (0.17)	5.49 (0.38)	H847X - 400 - †	H848X - 400 - †	
	60-600	30-280	4.47 (0.31)	10.71 (0.74)	H847X - 600 - †	H848X - 600 - †	
	80-800	50-350	6.13 (0.42)	17.14 (1.18)	H847X - 800 - †	H848X - 800 - †	

(example) H 737X - 250 - HE

NOTE: Consult factory for availability.

- ① SCFM/PSI multipressure scales are standard.
- ② L/sec/bar multipressure scales are available at no extra charge. Consult factory for other options.

NOTE: When ordering a L/sec/bar scale add "S1" suffix to part number

(example) H737 X - 250 - S1 or H737 X - 250 - HE - S1

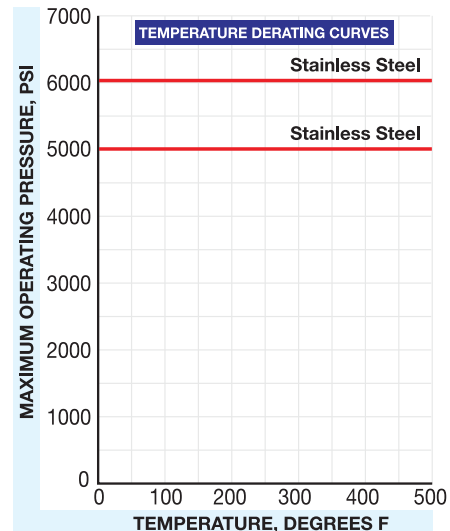

1000/1500 PSI Flow Meters

For Air and Other Compressed Gases

- Direct reading
- Install in any position
- 360° rotatable guard/scale
- Easier-to-read linear scale
- No flow straighteners or special piping required
- Relatively insensitive to shock and vibration
- Temperature up to 240 °F
- Accuracy $\pm 2\%$ full scale
- Repeatability $\pm 1\%$
- Special scales available
- Calibrated for 1.0 S.G.

SPECIFICATIONS:

MATERIALS:

2024 - T351 Anodized aluminum body, piston and cone

C360 Brass body, piston and cone[Ⓞ]

T303 Stainless body, 2024 - T351 Anodized aluminum piston and cone

COMMON PARTS:	Retaining Ring: T316 SS
Spider Plate: T316 SS	Retaining Spring: T316 SS
Spring: T302 SS	Indicator and Internal Magnet: PPS / Ceramic
Fasteners: T303 SS	Guard Seal / Bumper: Buna N
Pressure Seals: Viton [®]	Scale Support: 6063 - T6 Aluminum
Guard: Polycarbonate	End Caps: Nylon ST

THREADS: SAE J1926/1, NPTF ANSI B2.2, BSPP ISO1179

TEMPERATURE RANGE: -20 to +240 °F (-29 to +116 °C) for higher temperatures, consult factory

PRESSURE RATING:

Aluminum / Brass Operating: 1,000 psi/69 bar max. (250 psi/17 bar max. for 3" series) with a 10:1 safety factor.

For High Cycle Applications: See page 7

Stainless Steel Operating: 1,500 psi/103 bar max. with a 10:1 safety factor.

For High Cycle Applications: See page 7

PRESSURE DROP: See Ordering Information Table, page 42.

For detailed differential pressure charts, see page 66.

ACCURACY: $\pm 2\%$ of full scale, $\pm 7\%$ of full scale for 1/4" meters **REPEATABILITY:** $\pm 1\%$

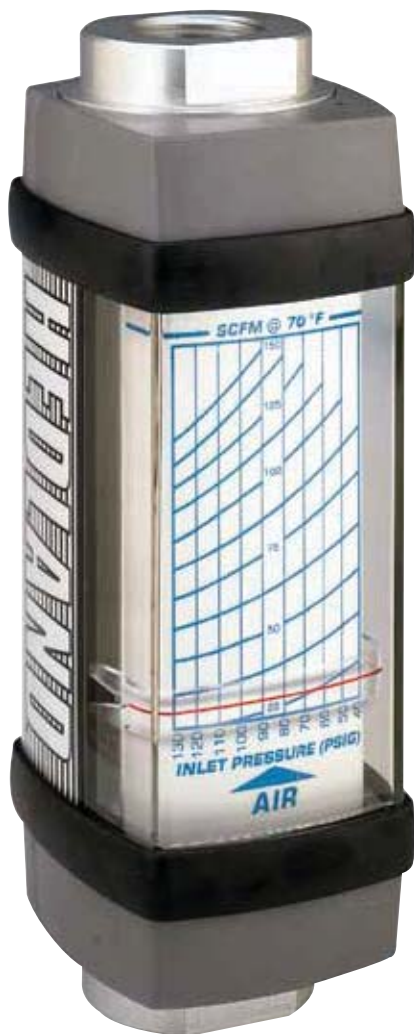

STANDARD PRODUCT

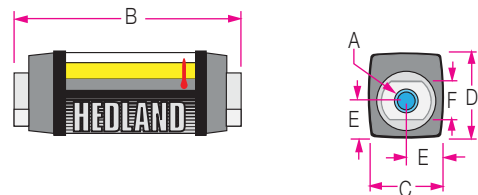

STANDARD PRODUCT WITH EP & EG OPTION

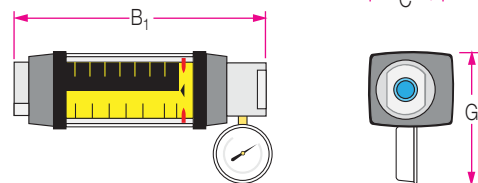

DIMENSIONS:

A	B	B ₁	C	D	E	F	G
NOMINAL PORT SIZE	LENGTH in (mm)	LENGTH in (mm)	WIDTH in (mm)	DEPTH in (mm)	OFFSET in (mm)	FLATS in (mm)	HEIGHT in (mm)
1/4 (SAE 6)	4.8 (122)	6.12 (155)	1.68 (43)	1.90 (48)	.84 (21)	.88 (22)	5.0 (127)
1/2 (SAE 10)	6.6 (168)	8.00 (203)	2.07 (53)	2.40 (61)	1.04 (26)	1.25 (32)	5.4 (137)
3/4 (SAE 12)	7.2 (183)	8.9 (226)	2.48 (63)	2.85 (72)	1.24 (32)	1.50 (38)	5.9 (150)
1 (SAE 16)	7.2 (183)	8.9 (226)	2.48 (63)	2.85 (72)	1.24 (32)	1.75 (44)	5.9 (150)
1 1/4 (SAE 20)	12.2 (310)	13.8 (351)	4.12 (105)	4.72 (120)	2.06 (52)	2.75 (70)	7.2 (183)
1 1/2 (SAE 24)	12.2 (310)	13.8 (351)	4.12 (105)	4.72 (120)	2.06 (52)	2.75 (70)	7.2 (183)

NOTE: Dimensions for 3" meters can be found on page 78.

Weights for all sizes can be found on page 79.

[Ⓞ]3 inch models have Celcon[®] piston/piston ring

Celcon is a registered trademark of Hoechst Celanese Corp.
Viton is a registered trademark of DuPont Dow Elastomers

1000/1500 PSI Flow Meters

For Air and Other Compressed Gases

ORDERING INFORMATION:

NOMINAL PORT SIZE ^②	FLOW RANGE		PRESSURE DROP		MODEL NUMBER (see example below)			MATERIAL			OPTIONS	
	③ SCFM	④ L/SEC	50% FLOW PSI (BAR)	100% FLOW PSI (BAR)	SAE	NPTF	BSPP ^⑤	ALUMINUM 1000 PSI	BRASS 1000 PSI	STAINLESS 1500 PSI	EXTENDED CAP PLUGGED ^⑥	EXTENDED CAP W/GAUGE ^⑥
¼" SAE 6	0.5 - 5	0.2 - 2.2	2.51 (0.17)	4.45 (0.31)	H270 * - 005 - †	H271 * - 005 - †	H272 * - 005 - †	A	B	S	EP	EG
	1 - 10	0.5 - 4.75	9.29 (0.64)	16.46 (1.13)	H270 * - 010 - †	H271 * - 010 - †	H272 * - 010 - †					
	2 - 20	1 - 9	10.15 (0.70)	18.71 (1.29)	H270 * - 020 - †	H271 * - 020 - †	H272 * - 020 - †					
	3 - 30	1.5 - 14	13.75 (0.95)	26.23 (1.81)	H270 * - 030 - †	H271 * - 030 - †	H272 * - 030 - †					
½" SAE 10	3 - 25	2 - 12	3.73 (0.26)	6.10 (0.42)	H670 * - 025 - †	H671 * - 025 - †	H672 * - 025 - †	A	B	S	EP	EG
	5 - 50	3 - 22	6.04 (0.42)	10.35 (0.71)	H670 * - 050 - †	H671 * - 050 - †	H672 * - 050 - †					
	10 - 100	5 - 47	7.18 (0.50)	13.85 (0.95)	H670 * - 100 - †	H671 * - 100 - †	H672 * - 100 - †					
	15 - 150	7 - 70	8.06 (0.56)	18.49 (1.27)	H670 * - 150 - †	H671 * - 150 - †	H672 * - 150 - †					
¾" SAE 12	3 - 25	1.5 - 11.5	2.99 (0.21)	5.90 (0.41)	H770 * - 025 - †	H771 * - 025 - †	H772 * - 025 - †	A	B	S	EP	EG
	5 - 50	2 - 23	2.00 (0.14)	3.58 (0.25)	H770 * - 050 - †	H771 * - 050 - †	H772 * - 050 - †					
	10 - 100	5 - 47.5	7.19 (0.50)	12.87 (0.89)	H770 * - 100 - †	H771 * - 100 - †	H772 * - 100 - †					
	15 - 150	7 - 70	4.44 (0.31)	9.52 (0.66)	H770 * - 150 - †	H771 * - 150 - †	H772 * - 150 - †					
1" SAE 16	3 - 25	1.5 - 11.5	2.99 (0.21)	5.90 (0.41)	H790 * - 025 - †	H791 * - 025 - †	H792 * - 025 - †	A	B	S	EP	EG
	5 - 50	2 - 23	2.00 (0.14)	3.58 (0.25)	H790 * - 050 - †	H791 * - 050 - †	H792 * - 050 - †					
	10 - 100	5 - 47.5	7.19 (0.50)	12.87 (0.89)	H790 * - 100 - †	H791 * - 100 - †	H792 * - 100 - †					
	15 - 150	7 - 70	4.44 (0.31)	9.52 (0.66)	H790 * - 150 - †	H791 * - 150 - †	H792 * - 150 - †					
1¼" SAE 20	20 - 200	10 - 95	1.89 (0.13)	3.16 (0.22)	H870 * - 200 - †	H871 * - 200 - †	H872 * - 200 - †	A	B	S	EP	EG
	40 - 400	20 - 180	2.53 (0.17)	5.49 (0.38)	H870 * - 400 - †	H871 * - 400 - †	H872 * - 400 - †					
	60 - 600	30 - 280	4.47 (0.31)	10.71 (0.74)	H870 * - 600 - †	H871 * - 600 - †	H872 * - 600 - †					
	80 - 800	50 - 350	6.13 (0.42)	17.14 (1.18)	H870 * - 800 - †	H871 * - 800 - †	H872 * - 800 - †					
1½" SAE 24	20 - 200	10 - 95	1.89 (0.13)	3.16 (0.22)	H890 * - 200 - †	H891 * - 200 - †	H892 * - 200 - †	A	B	S	EP	EG
	40 - 400	20 - 180	2.53 (0.17)	5.49 (0.38)	H890 * - 400 - †	H891 * - 400 - †	H892 * - 400 - †					
	60 - 600	30 - 280	4.47 (0.31)	10.71 (0.74)	H890 * - 600 - †	H891 * - 600 - †	H892 * - 600 - †					
	80 - 800	50 - 350	6.13 (0.42)	17.14 (1.18)	H890 * - 800 - †	H891 * - 800 - †	H892 * - 800 - †					
3"	100 - 1400	75 - 750	10.0 (0.69)	16.0 (1.10)	Not Available	H971 * - 140	H972 * - 140	250 PSI		Not Available		
	200 - 2200	75 - 1130	10.0 (0.69)	16.0 (1.10)		H971 * - 220	H972 * - 220	A	B			

NOTE: Consult factory for other options.

② Fractional sizes apply to NPTF and BSPP.

③ SCFM/PSI multipressure scales are standard.

④ L/sec/bar multipressure

scales are available at no extra charge.

⑤ 3 inch models have BSPT (BS21) threads

⑥ EP and EG options are only available with NPTF and BSPP models.

(example) H 771 A - 030 - EP



NOTE: When ordering a L/sec/bar scale add "S1" suffix to part number

(example) H771 A - 250 - S1 or H771 A - 250 - EG - S1

600 PSI Test Kits

For Air and Other Compressed Gases

- Direct reading
- Install in any position
- 360° rotatable guard/scale
- Easier-to-read linear scale
- No flow straighteners or special piping required
- Relatively insensitive to shock and vibration
- Temperature up to 240 °F
- Accuracy $\pm 2\%$ full scale
- Repeatability $\pm 1\%$
- Special scales available



SPECIFICATIONS:

MATERIALS:

2024 - T351 Anodized aluminum body, piston and cone

C360 Brass body, piston and cone

T303 Stainless body, 2024 - T351 Anodized aluminum piston and cone

COMMON PARTS: Retaining Ring: T316 SS
 Spider Plate: T316 SS Retaining Spring: T316 SS
 Spring: T302 SS Indicator and Internal Magnet: PPS / Ceramic
 Fasteners: T303 SS Guard Seal / Bumper: Buna N
 Pressure Seals: Viton® Scale Support: 6063 - T6 Aluminum
 Guard: Polycarbonate End Caps: Nylon ST

THREADS: NPTF ANSI B2.2, BSPP ISO1179

TEMPERATURE RANGE: -20 to +240 °F (-29 to +116 °C)

PRESSURE RATING:

Aluminum / Brass Operating: 600 psi/41 bar max. with a 10:1 safety factor.

For High Cycle Applications: See page 7

Stainless Steel Operating: 600 psi/41 bar max. with a 10:1 safety factor.

For High Cycle Applications: See page 7

PRESSURE DROP: See Ordering Information Table, page 44.

For detailed differential pressure charts, see page 66.

ACCURACY: $\pm 2\%$ of full scale, $\pm 7\%$ of full scale for $\frac{1}{4}$ " meters **REPEATABILITY:** $\pm 1\%$

PRESSURE GAUGE: Glycerin dampened, 0 - 160 psi / 0 - 10 bar pressure range available on all test kits.

LOAD VALVE: $\frac{1}{2}$ " to $1\frac{1}{2}$ " nickel-plated brass ball valve with chrome-plated brass ball and Teflon® seals.

SILENCER (optional) : Brass body with 40 micron porous sintered bronze filter.

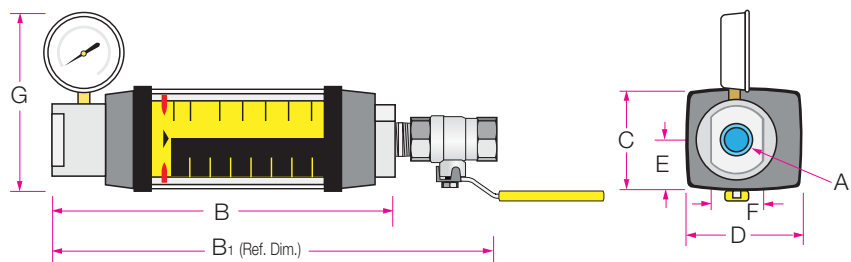

DIMENSIONS:

A	B	B ₁	C	D	E	F	G
NOMINAL PORT SIZE	LENGTH in (mm)	LENGTH in (mm)	WIDTH in (mm)	DEPTH in (mm)	OFFSET in (mm)	FLATS in (mm)	HEIGHT in (mm)
$\frac{1}{4}$	6.12 (155)	8.38 (213)	1.68 (43)	1.90 (48)	.84 (21)	.88 (22)	5.0 (127)
$\frac{1}{2}$	8.00 (203)	11.0 (279)	2.07 (53)	2.40 (61)	1.04 (26)	1.25 (32)	5.4 (137)
$\frac{3}{4}$	8.90 (226)	12.38 (315)	2.48 (63)	2.85 (72)	1.24 (32)	1.50 (38)	5.9 (150)
1	8.90 (226)	12.38 (315)	2.48 (63)	2.85 (72)	1.24 (32)	1.75 (44)	5.9 (150)
$1\frac{1}{4}$	13.80 (351)	18.39 (465)	4.12 (105)	4.72 (120)	2.06 (52)	2.75 (70)	7.2 (183)
$1\frac{1}{2}$	13.80 (351)	18.39 (465)	4.12 (105)	4.72 (120)	2.06 (52)	2.75 (70)	7.2 (183)

NOTE: Weights for all sizes can be found on page 79.

BSPP Test Kits include outlet adapter.

Teflon is a registered trademark of E.I. DuPont de Nemours & Co.

Viton is a registered trademark of DuPont Dow Elastomers

600 PSI Test Kits

For Air and Other Compressed Gases

ORDERING INFORMATION:

NOMINAL PORT SIZE	FLOW RANGE		PRESSURE DROP		MODEL NUMBER (see example below)		MATERIAL		
	① SCFM	② L/SEC	50% FLOW PSI (BAR)	100% FLOW PSI (BAR)	NPTF	BSPP	ALUMINUM 600 PSI	BRASS 600 PSI	STAINLESS 600 PSI
¼"	0.5 - 5	0.2 - 2.2	3.38 (0.23)	5.32 (0.37)	H271 * - 005 - TK	H272 * - 005 - TK	A	B	S
	1 - 10	0.5 - 4.75	8.08 (0.56)	17.33 (1.19)	H271 * - 010 - TK	H272 * - 010 - TK			
	2 - 20	1 - 9	11.02 (0.76)	19.64 (1.35)	H271 * - 020 - TK	H272 * - 020 - TK			
	3 - 30	1.5 - 14	14.62 (1.01)	27.10 (1.87)	H271 * - 030 - TK	H272 * - 030 - TK			
½"	3 - 25	2 - 12	4.60 (0.32)	6.97 (0.48)	H671 * - 025 - TK	H672 * - 025 - TK	A	B	S
	5 - 50	3 - 22	6.91 (0.48)	11.22 (0.77)	H671 * - 050 - TK	H672 * - 050 - TK			
	10 - 100	5 - 47	8.67 (0.60)	14.72 (1.01)	H671 * - 100 - TK	H672 * - 100 - TK			
	15 - 150	7 - 70	8.93 (0.62)	19.36 (1.33)	H671 * - 150 - TK	H672 * - 150 - TK			
¾"	3 - 25	1.5 - 11.5	3.86 (0.27)	6.77 (0.47)	H771 * - 025 - TK	H772 * - 025 - TK	A	B	S
	5 - 50	2 - 23	2.87 (0.20)	4.45 (0.31)	H771 * - 050 - TK	H772 * - 050 - TK			
	10 - 100	5 - 47.5	8.06 (0.56)	13.74 (0.95)	H771 * - 100 - TK	H772 * - 100 - TK			
	15 - 150	7 - 70	5.31 (0.37)	10.39 (0.72)	H771 * - 150 - TK	H772 * - 150 - TK			
1"	3 - 25	1.5 - 15	3.86 (0.27)	6.77 (0.47)	H791 * - 025 - TK	H792 * - 025 - TK	A	B	S
	5 - 50	2 - 23	2.87 (0.20)	4.45 (0.31)	H791 * - 050 - TK	H792 * - 050 - TK			
	10 - 100	5 - 47.5	8.06 (0.56)	13.74 (0.95)	H791 * - 100 - TK	H792 * - 100 - TK			
	15 - 150	7 - 70	5.31 (0.37)	10.39 (0.72)	H791 * - 150 - TK	H792 * - 150 - TK			
1¼"	20 - 200	10 - 95	2.76 (0.19)	4.03 (0.28)	H871 * - 200 - TK	H872 * - 200 - TK	A	B	S
	40 - 400	20 - 180	3.40 (0.23)	6.36 (0.44)	H871 * - 400 - TK	H872 * - 400 - TK			
	60 - 600	30 - 280	5.34 (0.37)	11.58 (0.80)	H871 * - 600 - TK	H872 * - 600 - TK			
	80 - 800	50 - 350	7.00 (0.48)	18.01 (1.24)	H871 * - 800 - TK	H872 * - 800 - TK			
1½"	20 - 200	10 - 95	2.76 (0.19)	4.03 (0.28)	H891 * - 200 - TK	H892 * - 200 - TK	A	B	S
	40 - 400	20 - 180	3.40 (0.23)	6.36 (0.44)	H891 * - 400 - TK	H892 * - 400 - TK			
	60 - 600	30 - 280	5.34 (0.37)	11.58 (0.80)	H891 * - 600 - TK	H892 * - 600 - TK			
	80 - 800	50 - 350	7.00 (0.48)	18.01 (1.24)	H891 * - 800 - TK	H892 * - 800 - TK			
100 - 1000	50 - 475	10.71 (0.74)	29.32 (2.02)	H891 * - 999 - TK	H892 * - 999 - TK				

NOTE: Consult factory for other options.

①SCFM/PSI multipressure scales are standard.

②L/sec-bar multipressure scales are available at no extra charge.

(example) H 771 A - 250 - TK



NOTE: When ordering a L/sec-bar scale add "S1" suffix to part number

(example) H771 A - 250 - TK - S1

Flow-Alert Flow Switches (Micro Switch)

For Liquids / Air and Other Compressed Gases

- Automatically signals alarm if flow is too high or too low
- Automatically opens or closes electrical circuits
- Triggers warning lights, buzzers and other devices
- Shuts down pumps and/or other equipment to protect your operation against permanent damage
- Available from ¼" to 1½" sizes in aluminum, brass and stainless
- Installs in any position
- Easier-to-read linear scale
- No flow straighteners or special piping requirements
- Relatively insensitive to shock and vibration
- Special scales available



SPECIFICATIONS:

MATERIALS:

2024 - T351 Anodized aluminum body, piston and cone

C360 Brass body, piston and cone

T303 Stainless body, 2024 - T351 Anodized aluminum piston and cone
(Oil, PE, WBF, & Air Meters)

T303 Stainless body, C360 Brass piston and cone (Water meters)

T316 Stainless body, piston and cone

PETROLEUM (Oil) COMMON PARTS:

Spider Plate: T316 SS

Retaining Ring: SAE 1070/1090 Carbon Steel

Spring: T302 SS

Retaining Spring: SAE 1070/1090 Carbon Steel

Fasteners: T303 SS

Indicator and Internal Magnet: PPS / Ceramic

Pressure Seals: Viton®

Enclosure Seal: Silicone gasket

Lens: Polycarbonate

Scale Support: 6063 - T6 Aluminum

PHOSPHATE ESTER (PE) COMMON PARTS:

Spider Plate: T316 SS

Retaining Ring: SAE 1070/1090 Carbon Steel

Spring: T302 SS

Retaining Spring: SAE 1070/1090 Carbon Steel

Fasteners: T303 SS

Indicator and Internal Magnet: PPS / Ceramic

Pressure Seals: EPR

Enclosure Seal: Silicone gasket

Lens: Polycarbonate

Scale Support: 6063 - T6 Aluminum

WATER-BASED (WBF), WATER, AIR COMMON PARTS:

Spider Plate: T316 SS

Retaining Ring: T316 SS

Spring: T302 SS

Retaining Spring: T316 SS

Fasteners: T303 SS

Indicator and Internal Magnet: PPS / Ceramic

Pressure Seals: Viton®

Enclosure Seal: Silicone gasket

Lens: Polycarbonate

Scale Support: 6063 - T6 Aluminum

API OIL / AIR / CAUSTIC and CORROSIVE LIQUIDS and GASES:

Spider Plate: T316 SS

Retaining Ring: T316 SS

Spring: T316 SS

Retaining Spring: T316 SS

Fasteners: T316 SS

Indicator and Internal Magnet: PPS / Ceramic

Pressure Seals: Viton®

Enclosure Seal: Silicone gasket

Lens: Polycarbonate

Scale Support: 6063 - T6 Aluminum

THREADS: SAE J1926/1, NPTF ANSI B2.2, BSPP ISO1179

TEMPERATURE RANGE: -20 to +240 °F (-29 to +116 °C)

PRESSURE RATING:

Aluminum / Brass Operating:

Liquids - 3,500 psi/241 bar max. with a 3:1 safety factor.

Gases - 1,000 psi/69 bar max. with a 10:1 safety factor.

For High Cycle Applications: See page 7

Stainless Steel Operating:

Liquids - 6,000 psi/414 bar max. with a 3:1 safety factor.

Gases - 1,500 psi/103 bar max. with a 10:1 safety factor.

For High Cycle Applications: See page 7

ACCURACY: ±2% of full scale

REPEATABILITY: ±1%

PRESSURE DROP REFERENCE TABLE:

	FLUID TYPE							
	Oil	PE	WBF	Water	API Oil	Caustic & Corrosive Liquids	Air/Caustic & Corrosive Gases	Air
50% / 100% Pressure Drop	p. 10	p. 18	p. 26	p. 34	p. 38	p. 38	p. 40	p. 42
Pressure Drop Chart	p. 61	p. 62	p. 63	p. 64	p. 65	p. 64	p. 65	p. 66

Viton is a registered trademark of DuPont Dow Elastomers

Flow-Alert Flow Switches (Micro Switch)

For Liquids / Air and Other Compressed Gases



DIMENSIONS:

A	B	C	D	E	F	G	H	I	J	K
NOMINAL PORT SIZE	LENGTH in (mm)	LENGTH in (mm)	LENGTH in (mm)	WIDTH in (mm)	WIDTH in (mm)	WIDTH in (mm)	WIDTH in (mm)	DEPTH in (mm)	OFFSET in (mm)	HOLE DIA. in (mm)
¼ (SAE 6)	6.6 (168)	5.27 (134)	6.41 (163)	6.00 (152)	3.23 (82)	3.00 (76)	4.20 (107)	2.94 (75)	1.51 (38)	.31 (8)
½ (SAE 10)	6.6 (168)	5.27 (134)	6.41 (163)	6.00 (152)	3.23 (82)	3.00 (76)	4.20 (107)	2.94 (75)	1.51 (38)	.31 (8)
¾ (SAE 12)	7.2 (183)	5.27 (134)	7.04 (179)	6.00 (152)	3.60 (91)	3.00 (76)	4.20 (107)	2.94 (75)	1.27 (32)	.31 (8)
1 (SAE 16)	7.2 (183)	5.27 (134)	7.04 (179)	6.00 (152)	3.60 (91)	3.00 (76)	4.20 (107)	2.94 (75)	1.27 (32)	.31 (8)
1¼ (SAE 20)	12.2 (310)	10.68 (271)	11.65 (296)	7.63 (194)	4.84 (123)	3.82 (97)	5.02 (128)	4.50 (114)	2.20 (56)	.31 (8)
1½ (SAE 24)	12.2 (310)	10.68 (271)	11.65 (296)	7.63 (194)	4.84 (123)	3.82 (97)	5.02 (128)	4.50 (114)	2.20 (56)	.31 (8)

ENCLOSURE:

Material: Anodized and epoxy powder-coated aluminum with polycarbonate lens.

Seals: Silicone gasket between enclosure and lens.

Viton® O-rings between enclosure and flow meter body.

Connection: Pig-tail conductor (standard) with water-tight strain relief.

Other connections, including quick-disconnect, are available – consult factory for details.

Fastener: T303 SS

Rating: NEMA 12 & 13 (IP52/54)

ELECTRICAL CIRCUITRY:

Adjustable Flow-Alert signal: single (1) or double (2) switch, pre-wired single-pole, double-throw (SPDT) with high or low flow limit setting, adjustable over the entire flow measuring range. Other switches are available – consult factory for details.

10A @ 250 VAC maximum, 0.5A @ 125 VDC maximum.

All Flow-Alert sizes (¼ to 1½ inch series) are offered in single (1) switch or double (2) switch models.

The single switch model is supplied with a 34" length of 4-wire #18 AWG jacketed cable.

The double switch model is supplied with an 18" length of 7-wire #16 AWG jacketed cable.

Optional 8 ft. cables are available – consult factory for details.

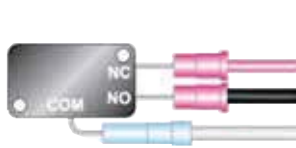

One (1) Switch 4-wire cable

Red: Normally Closed (NC)

Black: Normally Open (NO)

White: Common (COM)

Green: Ground

Two (2) Switch 7-wire cable

Switch #1

Red: Normally Closed (NC)

Black: Normally Open (NO)

White: Common (COM)

Switch #2

Orange: Normally Closed (NC)

Blue: Normally Open (NO)

White/Black: Common (COM)

Green: Ground

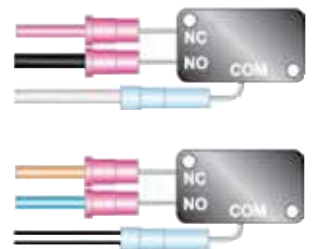

NOTE: Weights for all sizes can be found on page 79.

Flow-Alert Flow Switches (Reed Switch)

For Liquids / Air and Other Compressed Gases

- No mechanical linkage
- Automatically signals alarm if flow is too high or too low
- Available from ¼" to 1½" sizes in aluminum, brass and stainless
- Installs in any position
- Easier-to-read linear scale
- No flow straighteners or special piping requirements
- Relatively insensitive to shock and vibration
- Special scales available



SPECIFICATIONS:

MATERIALS:

2024 - T351 Anodized aluminum body, piston and cone
 C360 Brass body, piston and cone
 T303 Stainless body, 2024 - T351 Anodized aluminum piston and cone
 (Oil, PE, WBF, & Air meters)
 T303 Stainless body, C360 Brass piston and cone (Water meters)
 T316 Stainless body, piston and cone

PETROLEUM (Oil) COMMON PARTS:

Spider Plate: T316 SS **Retaining Ring:** SAE 1070/1090 Carbon Steel
Spring: T302 SS **Retaining Spring:** SAE 1070/1090 Carbon Steel
Fasteners: T303 SS **Indicator:** T400 Series Stainless
Pressure Seals: Viton® **Internal Magnet:** Teflon® Coated Alnico 8
Lens: Polycarbonate **Switch Carrier:** Aluminum
Enclosure Seal: Silicone gasket **Scale Support:** 6063 - T6 Aluminum

PHOSPHATE ESTER (PE) COMMON PARTS:

Spider Plate: T316 SS **Retaining Ring:** SAE 1070/1090 Carbon Steel
Spring: T302 SS **Retaining Spring:** SAE 1070/1090 Carbon Steel
Fasteners: T303 SS **Indicator:** T400 Series Stainless
Pressure Seals: EPR **Internal Magnet:** Teflon® Coated Alnico 8
Lens: Polycarbonate **Switch Carrier:** Aluminum
Enclosure Seal: Silicone gasket **Scale Support:** 6063 - T6 Aluminum

WATER-BASED (WBF), WATER, AIR COMMON PARTS:

Spider Plate: T316 SS **Retaining Ring:** T316 SS
Spring: T302 SS **Retaining Spring:** T316 SS
Fasteners: T303 SS **Indicator:** T400 Series Stainless
Pressure Seals: Viton® **Internal Magnet:** Teflon® Coated Alnico 8
Lens: Polycarbonate **Switch Carrier:** Aluminum
Enclosure Seal: Silicone gasket **Scale Support:** 6063 - T6 Aluminum

API OIL / AIR / CAUSTIC and CORROSIVE LIQUIDS and GASES:

Spider Plate: T316 SS **Retaining Ring:** T316 SS
Spring: T316 SS **Retaining Spring:** T316 SS
Fasteners: T316 SS **Indicator:** T400 Series Stainless
Pressure Seals: Viton® **Internal Magnet:** Teflon® Coated Alnico 8
Lens: Polycarbonate **Switch Carrier:** Aluminum
Enclosure Seal: Silicone gasket **Scale Support:** 6063 - T6 Aluminum

THREADS: SAE J1926/1, NPTF ANSI B2.2, BSPP ISO1179

TEMPERATURE RANGE: -20 to +240 °F (-20 to +116 °C)

PRESSURE RATING:

Aluminum / Brass Operating:

Liquids - 3,500 psi/241 bar max. with a 3:1 safety factor.

Gases - 1,000 psi/69 bar max. with a 10:1 safety factor.

For High Cycle Applications: See page 7

Stainless Steel Operating:

Liquids - 6,000 psi/414 bar max. with a 3:1 safety factor.

Gases - 1,500 psi/103 bar max. with a 10:1 safety factor.

For High Cycle Applications: See page 7

ACCURACY: ±2% of full scale, ±7% of full scale for 4.8" (122 mm) length ¼" meters

REPEATABILITY: ±1%

PRESSURE DROP REFERENCE TABLE:

	FLUID TYPE							
	Oil	PE	WBF	Water	API Oil	Caustic & Corrosive Liquids	Air/Caustic & Corrosive Gases	Air
50% / 100% Pressure Drop	p. 10	p. 18	p. 26	p. 34	p. 38	p. 38	p. 40	p. 42
Pressure Drop Chart	p. 61	p. 62	p. 63	p. 64	p. 65	p. 64	p. 65	p. 66

Teflon is a registered trademark of E.I. du Pont de Nemours and Co.
 Viton is a registered trademark of DuPont Dow Elastomers

Flow-Alert Flow Switches (Reed Switch)

For Liquids / Air and Other Compressed Gases



DIMENSIONS:

A	B	C	D	E	F	G	H	I	J	K
NOMINAL PORT SIZE	LENGTH in (mm)	LENGTH in (mm)	LENGTH in (mm)	WIDTH in (mm)	WIDTH in (mm)	WIDTH in (mm)	WIDTH in (mm)	DEPTH in (mm)	OFFSET in (mm)	HOLE DIA. in (mm)
¼ (SAE 6)	6.6 (168)	5.27 (134)	6.41 (163)	6.00 (152)	3.23 (82)	3.00 (76)	4.20 (107)	2.94 (75)	1.51 (38)	.31 (8)
½ (SAE 10)	6.6 (168)	5.27 (134)	6.41 (163)	6.00 (152)	3.23 (82)	3.00 (76)	4.20 (107)	2.94 (75)	1.51 (38)	.31 (8)
¾ (SAE 12)	7.2 (183)	5.27 (134)	7.04 (179)	6.00 (152)	3.60 (91)	3.00 (76)	4.20 (107)	2.94 (75)	1.27 (32)	.31 (8)
1 (SAE 16)	7.2 (183)	5.27 (134)	7.04 (179)	6.00 (152)	3.60 (91)	3.00 (76)	4.20 (107)	2.94 (75)	1.27 (32)	.31 (8)
1¼ (SAE 20)	12.2 (310)	10.68 (271)	11.65 (296)	7.63 (194)	4.84 (123)	3.82 (97)	5.02 (128)	4.50 (114)	2.20 (56)	.31 (8)
1½ (SAE 24)	12.2 (310)	10.68 (271)	11.65 (296)	7.63 (194)	4.84 (123)	3.82 (97)	5.02 (128)	4.50 (114)	2.20 (56)	.31 (8)

DIMENSIONS:

A	B	C	D	E	F
NOMINAL PORT SIZE	LENGTH in (mm)	WIDTH in (mm)	DEPTH in (mm)	OFFSET in (mm)	FLATS in (mm)
¼ (SAE 6)	4.8 (122)	1.68 (43)	1.90 (48)	.84 (21)	.88 (22)

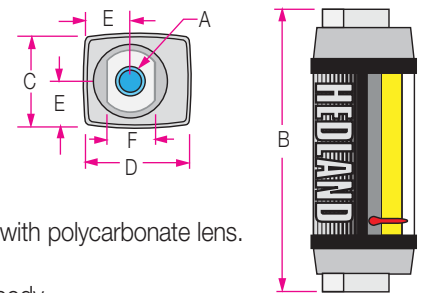

ENCLOSURE:

Material: Anodized and epoxy powder-coated aluminum with polycarbonate lens.

Seals: Silicone gasket between enclosure and lens.

Viton® O-rings between enclosure and flow meter body.

Connection: 4-pin (Protection Class IP65)

Fastener: T303 SS

Rating: NEMA 12 & 13 (IP 52/54)

ELECTRICAL SPECIFICATIONS:

Adjustable Flow-Alert signal: single (1) or double (2) reed switch, pre-wired single-pole, single-throw (SPST-NO) normally open; or single-pole, single-throw (SPST-NC) normally closed, with high or low flow limit setting, adjustable over the entire flow measuring range.

Figure 1

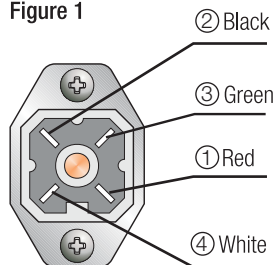

Electrical Circuitry:

The flow switch is supplied with 15 feet of shielded, 4-wire #22 AWG PVC jacketed cable, color coded as follows: ① Red, ② Black for single (1) Reed Switch, and ③ Green, ④ White for double (2) Reed Switch.

Contact Form	SPST-NO	SPST-NC
ELECTRICAL SPECIFICATIONS		
Contact Rating	10 Watts Max	5 Watts Max
Voltage, Switching	50 VDC Max	50 VDC Max
Current (resistive), Switching	0.500 A Max	0.500 A Max
OPERATING SPECIFICATIONS		
Contact Resistance, Initial	0.100 Ω Max	0.100 Ω Max
Operating Temperature	20 to +240 °F (-20 to +116 °C)	-20 to +240 °F (-20 to +116 °C)

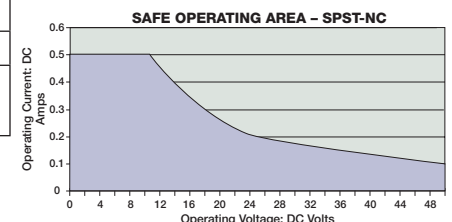
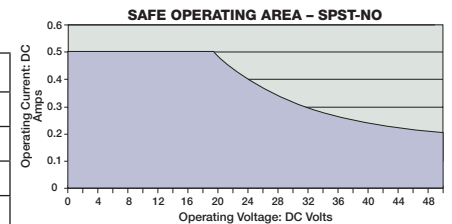

NOTE: Weights for all sizes can be found on page 79.

MR Flow Transmitters

For Liquids / Air and Other Compressed Gases

- Full line of multi-functional remote flow indicators and transmitters
- Operate as part of a totally integrated electronic process control/data acquisition system
- Non-contact sensor electronics
- Electronic signal conditioning circuit
- Digital flow rate and total flow indication
- Proportional analog output
- In-field compensation for-
Specific gravity of all fluids
Viscosity of petroleum-based fluids
Specific gravity, pressure, and temperature of pneumatic systems
- CE compliant- exceeds US and meets European standards for EMI/EMC
- US Patent 7,130,750



SPECIFICATIONS:

MATERIALS:

2024 - T351 Anodized aluminum body, piston and cone

C360 Brass body, piston and cone

T303 Stainless body, 2024 - T351 Anodized aluminum piston and cone
(Oil, PE, WBF, & Air meters)

T303 Stainless body, C360 Brass piston and cone (Water meters)

T316 Stainless body, piston and cone

PETROLEUM (Oil) COMMON PARTS:

Spider Plate: T316 SS **Retaining Ring:** SAE 1070/1090 Carbon Steel
Spring: T302 SS **Retaining Spring:** SAE 1070/1090 Carbon Steel
Fasteners: T303 SS **Internal Magnet:** Teflon® Coated Alnico 8
Pressure Seals: Viton® **Enclosure Seal:** Silicone gasket
Lens: Polycarbonate

PHOSPHATE ESTER (PE) COMMON PARTS:

Spider Plate: T316 SS **Retaining Ring:** SAE 1070/1090 Carbon Steel
Spring: T302 SS **Retaining Spring:** SAE 1070/1090 Carbon Steel
Fasteners: T303 SS **Internal Magnet:** Teflon® Coated Alnico 8
Pressure Seals: EPR **Enclosure Seal:** Silicone gasket
Lens: Polycarbonate

WATER-BASED (WBF), WATER, AIR COMMON PARTS:

Spider Plate: T316 SS **Retaining Ring:** T316 SS
Spring: T302 SS **Retaining Spring:** T316 SS
Fasteners: T303 SS **Internal Magnet:** Teflon® Coated Alnico 8
Pressure Seals: Viton® **Enclosure Seal:** Silicone gasket
Lens: Polycarbonate

API OIL / AIR / CAUSTIC and CORROSIVE LIQUIDS and GASES:

Spider Plate: T316 SS **Retaining Ring:** T316 SS
Spring: T316 SS **Retaining Spring:** T316 SS
Fasteners: T316 SS **Internal Magnet:** Teflon® Coated Alnico 8
Pressure Seals: Viton® **Enclosure Seal:** Silicone gasket
Lens: Polycarbonate

THREADS: SAE J1926/1, NPTF ANSI B2.2, BSPP ISO1179

TEMPERATURE RANGE: -20 to +240 °F (-29 to +116 °C)

PRESSURE RATING:

Aluminum / Brass Operating:

Liquids - 3,500 psi/241 bar maximum with a 3:1 safety factor.

Gases - 1,000 psi/69 bar maximum with a 10:1 safety factor.

For High Cycle Applications: See page 7

Stainless Steel Operating:

Liquids - (1/4" to 1/2") - 6,000 psi/414 bar maximum with a 3:1 safety factor

Liquids - (3/4" to 1 1/2") - 5,000 psi/345 bar maximum with a 3:1 safety factor

Gases - 1,500 psi/103 bar maximum with a 10:1 safety factor.

For High Cycle Applications: See page 7

ACCURACY: ±2% of full scale

REPEATABILITY: ±1%

PRESSURE DROP REFERENCE TABLE:

	FLUID TYPE							
	Oil	PE	WBF	Water	API Oil	Caustic & Corrosive Liquids	Air/Caustic & Corrosive Gases	Air
50% / 100% Pressure Drop	p. 10	p. 18	p. 26	p. 34	p. 38	p. 38	p. 40	p. 42
Pressure Drop Chart	p. 61	p. 62	p. 63	p. 64	p. 65	p. 64	p. 65	p. 66

Viton is a registered trademark of DuPont Dow Elastomers
Teflon is a registered trademark of E.I. DuPont de Nemours & Co.

MR Flow Transmitters

For Liquids / Air and Other Compressed Gases

ENCLOSURE:

- Material:** Anodized and epoxy powder-coated aluminum with polycarbonate lens
- Seals:** Silicone gaskets between enclosure and lens
Viton® O-rings between enclosure and flow meter body
- Connection:** 4-pin (Protection Class IP65) standard, see Figure 2
Other connections available - consult factory for details
- Fasteners:** T303 SS
- Rating:** NEMA 12 & 13 (IP 52/54)

ELECTRICAL SPECIFICATIONS:

- Power Requirement:** 0-5 VDC Output: 10-30 VDC @ 0.75W maximum
0-10 VDC Output: 12-30 VDC @ 0.75W maximum
4-20 mA Output: loop-powered, 30 VDC maximum
- Power Consumption:** 25 mA maximum
- Analog Outputs:** 0-5 VDC and 0-10 VDC into 10,000 Ohms minimum
4-20 mA into 1000 Ohms maximum, see Figure 1
- Circuit Protection:** Reverse polarity and current limiting
- Transmission Distance:** 4-20 mA limited by cable resistance
0-5 VDC and 0-10 VDC 1000 feet (300 m) maximum
Inherently isolated from the piping system
- Isolation:**
- Display:** Fixed or toggle modes of operation for rate and totalizer display
8 digit, 0.70" high numeric display for rate and total
8 digit, 0.35" high alphanumeric display for units and setup
- Temperature Drift:** 50 ppm / °C (max)
- Analog Output:** Resolution - 1:4000
- Transient Over-Voltages:** Category 3, in accordance with IEC 664
- Pollution Degree:** Category 2, in accordance with IEC 664
- Approvals:** EMC Directive 89/336/EEC

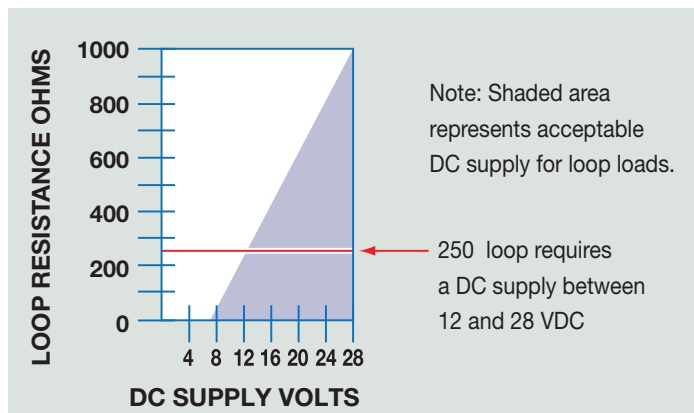
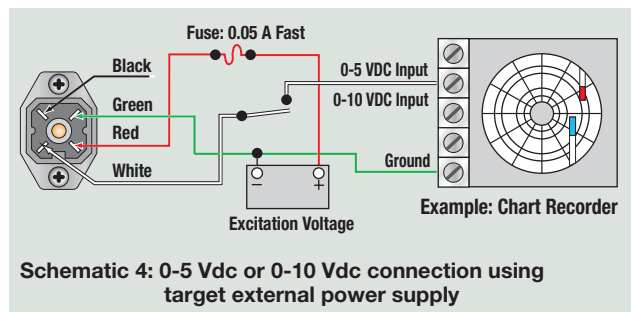
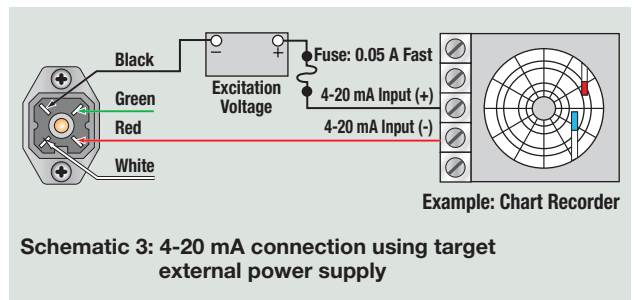
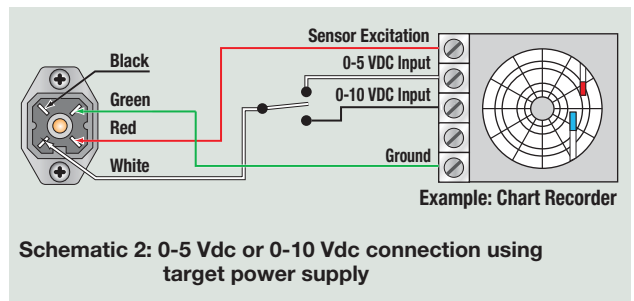
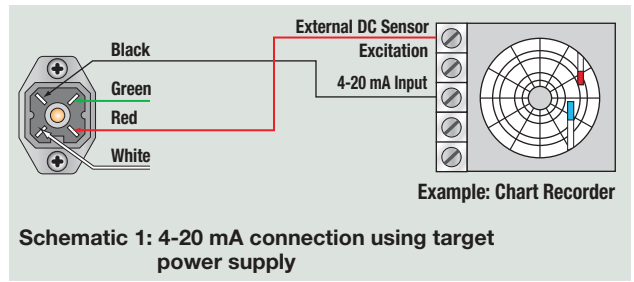

Figure 1. Load Limitations (4-20 mA Output Only)

SCHEMATICS:

The transmitter can be wired in various configurations to allow interface with many different types of data collection and control instrumentation.

Schematics 1 & 2 represent typical wiring for a target powered by either AC power or DC supply. Schematics 3 & 4 will be utilized when the flow transmitter is operated with loop-powered process indicators or data loggers that do not have external sensor excitation available.



	DC Output Connection	Loop Power Connection
2 Black:	No Connection	(-) 4-20 mA Out
3 Green:	0 VDC	No Connection
1 Red:	(+) DC Power	(+) 4-20 mA In
4 White:	0-5 VDC or 0-10 VDC Output	No Connection

Figure 2. Electrical 4-Pin Connection

MR Flow Transmitters

For Liquids / Air and Other Compressed Gases

Dimensions:

A	B	C	D	E	F	G	H	I	J	K
NOMINAL PORT SIZE	LENGTH in (mm)	LENGTH in (mm)	LENGTH in (mm)	WIDTH in (mm)	WIDTH in (mm)	WIDTH in (mm)	WIDTH in (mm)	DEPTH in (mm)	OFFSET in (mm)	HOLE DIA. in (mm)
¼ (SAE 6)	6.60 (168)	5.27 (134)	6.41 (163)	6.00 (152)	3.23 (82)	3.00 (76)	4.20 (107)	2.94 (75)	1.51 (38)	.31 (8)
½ (SAE 10)	6.60 (168)	5.27 (134)	6.41 (163)	6.00 (152)	3.23 (82)	3.00 (76)	4.20 (107)	2.94 (75)	1.51 (38)	.31 (8)
¾ (SAE 12)	7.20 (183)	5.27 (134)	7.04 (179)	6.00 (152)	3.60 (91)	3.00 (76)	4.20 (107)	2.94 (75)	1.27 (32)	.31 (8)
1 (SAE 16)	7.20 (183)	5.27 (134)	7.04 (179)	6.00 (152)	3.60 (91)	3.00 (76)	4.20 (107)	2.94 (75)	1.27 (32)	.31 (8)
1¼ (SAE 20)	12.20 (310)	10.68 (271)	11.65 (296)	7.63 (194)	4.84 (123)	3.82 (97)	5.02 (128)	4.50 (114)	2.20 (56)	.31 (8)
1½ (SAE 24)	12.20 (310)	10.68 (271)	11.65 (296)	7.63 (194)	4.84 (123)	3.82 (97)	5.02 (128)	4.50 (114)	2.20 (56)	.31 (8)



Optional Remote Display and Signal Processor:

Hedland also offers the F6700/F6750 Series Digital Display with integrated signal processor capabilities to further enhance the utility of the MR Flow Transmitters. In addition to remote flow monitoring, these units can be configured to provide alarm processing and communication options including RS232, RS485, Modbus, Profibus and DeviceNet. For complete product specifications, refer to page 59.



Flow-Alert Flow Switches and Flow Transmitters For Petroleum Fluids

ORDERING INFORMATION:

NOMINAL PORT SIZE [Ⓛ]	FLOW RANGE		MODEL NUMBER (see example below)			MATERIAL			OPTIONS		
	GPM	LPM	SAE	NPTF	BSPP	ALUMINUM 3500 PSI	BRASS 3500 PSI	STAINLESS	Flow-Alert 1 SWITCH / 2 SWITCH	Flow-Alert REED SWITCH	MULTIPLE OUTPUT SENSOR
¼" SAE 6	.02 - 0.2	0.1 - 0.75	H200 * - 002 - †	H201 * - 002 - †	H202 * - 002 - †	A	B	S	Not Available		Not Available
	.05 - 0.5	0.2 - 1.9	H200 * - 005 - †	H201 * - 005 - †	H202 * - 005 - †						
¼" SAE 6	0.1 - 1.0	0.5 - 3.75	H200 * - 010 - †	H201 * - 010 - †	H202 * - 010 - †	A	B	S	F1/F2		MR
	0.2 - 2.0	1.0 - 7.5	H200 * - 020 - †	H201 * - 020 - †	H202 * - 020 - †						
½" SAE 10	0.1 - 1.0	0.5 - 3.75	H600 * - 001 - †	H601 * - 001 - †	H602 * - 001 - †	A	B	S	F1/F2		MR
	0.2 - 2.0	1 - 7.5	H600 * - 002 - †	H601 * - 002 - †	H602 * - 002 - †						
	0.5 - 5.0	2 - 19	H600 * - 005 - †	H601 * - 005 - †	H602 * - 005 - †						
	1 - 10	5 - 38	H600 * - 010 - †	H601 * - 010 - †	H602 * - 010 - †						
	1 - 15	4 - 56	H600 * - 015 - †	H601 * - 015 - †	H602 * - 015 - †						
¾" SAE 12	0.2 - 2.0	1 - 7.5	H700 * - 002 - †	H701 * - 002 - †	H702 * - 002 - †	A	B	S	F1/F2		MR
	0.5 - 5.0	2 - 19	H700 * - 005 - †	H701 * - 005 - †	H702 * - 005 - †						
	1 - 10	5 - 38	H700 * - 010 - †	H701 * - 010 - †	H702 * - 010 - †						
	2 - 20	10 - 76	H700 * - 020 - †	H701 * - 020 - †	H702 * - 020 - †						
	3 - 30	10 - 115	H700 * - 030 - †	H701 * - 030 - †	H702 * - 030 - †						
1" SAE 16	0.2 - 2.0	1 - 7.5	H760 * - 002 - †	H761 * - 002 - †	H762 * - 002 - †	A	B	S	F1/F2		MR
	0.5 - 5.0	2 - 19	H760 * - 005 - †	H761 * - 005 - †	H762 * - 005 - †						
	1 - 10	5 - 38	H760 * - 010 - †	H761 * - 010 - †	H762 * - 010 - †						
	2 - 20	10 - 76	H760 * - 020 - †	H761 * - 020 - †	H762 * - 020 - †						
	3 - 30	10 - 115	H760 * - 030 - †	H761 * - 030 - †	H762 * - 030 - †						
	4 - 40	15 - 150	H760 * - 040 - †	H761 * - 040 - †	H762 * - 040 - †						
	5 - 50	20 - 190	H760 * - 050 - †	H761 * - 050 - †	H762 * - 050 - †						
1¼" SAE 20	3 - 30	10 - 110	H800 * - 030 - †	H801 * - 030 - †	H802 * - 030 - †	A	B	S	F1/F2		MR
	5 - 50	20 - 190	H800 * - 050 - †	H801 * - 050 - †	H802 * - 050 - †						
	10 - 75	40 - 280	H800 * - 075 - †	H801 * - 075 - †	H802 * - 075 - †						
	10 - 100	50 - 380	H800 * - 100 - †	H801 * - 100 - †	H802 * - 100 - †						
	10 - 100	50 - 380	H800 * - 100 - †	H801 * - 100 - †	H802 * - 100 - †						
	10 - 150	50 - 560	H800 * - 150 - †	H801 * - 150 - †	H802 * - 150 - †						
1½" SAE 24	3 - 30	10 - 110	H860 * - 030 - †	H861 * - 030 - †	H862 * - 030 - †	A	B	S	F1/F2		MR
	5 - 50	20 - 190	H860 * - 050 - †	H861 * - 050 - †	H862 * - 050 - †						
	10 - 75	40 - 280	H860 * - 075 - †	H861 * - 075 - †	H862 * - 075 - †						
	10 - 100	50 - 380	H860 * - 100 - †	H861 * - 100 - †	H862 * - 100 - †						
	10 - 150	50 - 560	H860 * - 150 - †	H861 * - 150 - †	H862 * - 150 - †						

SEE OPTIONS BELOW

ⓁFractional sizes apply to NPTF and BSPP.

(example) H 701 **A** - 030 - **F1** or **F2**



Flow-Alert Flow Switches

F1 = Single Switch
F2 = Double Switch

(example) H 701 **A** - 030 - **RS1NO**



Flow-Alert Reed Switches

Options:

- RS1NO (reed switch one (1) normally open)
- RS2NO (reed switch two (2) normally open)
- RS1NC (reed switch one (1) normally closed)
- RS2NC (reed switch two (2) normally closed)

(example) H 701 **A** - 030 - **MR**



Multiple Output Flow Sensor

3 Standard field selectable outputs

0-5 VDC } Flow Transmitter is factory-calibrated to provide 4 mA (0 VDC) at zero flow
0-10 VDC } and 20 mA (5/10 VDC) at full flow. Optional 5-point calibration certificate available
4-20 mA } (see Price and Availability Digest for details).

NOTE: ¼" liquid meters for .02-0.2 and .05-0.5 GPM ranges available in strap-on design for RS1NO and RS1NC only.

NOTE: For 50% and 100% flow/pressure drop information, see page 16. For detailed flow/pressure drop charts, see page 61.

Flow-Alert Flow Switches and Flow Transmitters For Phosphate Ester Fluids

ORDERING INFORMATION:

NOMINAL PORT SIZE ^①	FLOW RANGE		MODEL NUMBER (see example below)			MATERIAL			OPTIONS		
	GPM	LPM	SAE	NPTF	BSPP	ALUMINUM 3500 PSI	BRASS 3500 PSI	STAINLESS	Flow-Alert 1 SWITCH / 2 SWITCH	Flow-Alert REED SWITCH	MULTIPLE OUTPUT SENSOR
1/4" SAE 6	.02 - 0.2	0.1 - 0.75	H294 * - 002 - †	H295 * - 002 - †	H296 * - 002 - †	A	B	6000 PSI S	Not Available	SEE OPTIONS BELOW	Not Available
	.05 - 0.5	0.2 - 1.9	H294 * - 005 - †	H295 * - 005 - †	H296 * - 005 - †						
1/4" SAE 6	0.1 - 1.0	0.5 - 3.75	H294 * - 010 - †	H295 * - 010 - †	H296 * - 010 - †	A	B	6000 PSI S	F1/F2		MR
	0.2 - 2.0	1.0 - 7.5	H294 * - 020 - †	H295 * - 020 - †	H296 * - 020 - †						
1/2" SAE 10	0.1 - 1.0	0.5 - 3.75	H694 * - 001 - †	H695 * - 001 - †	H696 * - 001 - †	A	B	6000 PSI S	F1/F2		MR
	0.2 - 2.0	1 - 7.5	H694 * - 002 - †	H695 * - 002 - †	H696 * - 002 - †						
	0.5 - 5.0	2 - 19	H694 * - 005 - †	H695 * - 005 - †	H696 * - 005 - †						
	1 - 10	5 - 38	H694 * - 010 - †	H695 * - 010 - †	H696 * - 010 - †						
	1 - 15	4 - 56	H694 * - 015 - †	H695 * - 015 - †	H696 * - 015 - †						
3/4" SAE 12	0.2 - 2.0	1 - 7.5	H794 * - 002 - †	H795 * - 002 - †	H796 * - 002 - †	A	B	5000 PSI S	F1/F2	MR	
	0.5 - 5.0	2 - 19	H794 * - 005 - †	H795 * - 005 - †	H796 * - 005 - †						
	1 - 10	5 - 38	H794 * - 010 - †	H795 * - 010 - †	H796 * - 010 - †						
	2 - 20	10 - 76	H794 * - 020 - †	H795 * - 020 - †	H796 * - 020 - †						
	3 - 30	10 - 115	H794 * - 030 - †	H795 * - 030 - †	H796 * - 030 - †						
1" SAE 16	0.2 - 2.0	1 - 7.5	H764 * - 002 - †	H765 * - 002 - †	H766 * - 002 - †	A	B	5000 PSI S	F1/F2	MR	
	0.5 - 5.0	2 - 19	H764 * - 005 - †	H765 * - 005 - †	H766 * - 005 - †						
	1 - 10	5 - 38	H764 * - 010 - †	H765 * - 010 - †	H766 * - 010 - †						
	2 - 20	10 - 76	H764 * - 020 - †	H765 * - 020 - †	H766 * - 020 - †						
	3 - 30	10 - 115	H764 * - 030 - †	H765 * - 030 - †	H766 * - 030 - †						
	4 - 40	15 - 150	H764 * - 040 - †	H765 * - 040 - †	H766 * - 040 - †						
	5 - 50	20 - 190	H764 * - 050 - †	H765 * - 050 - †	H766 * - 050 - †						
1 1/4" SAE 20	3 - 30	10 - 110	H894 * - 030 - †	H895 * - 030 - †	H896 * - 030 - †	A	B	5000 PSI S	F1/F2	MR	
	5 - 50	20 - 190	H894 * - 050 - †	H895 * - 050 - †	H896 * - 050 - †						
	10 - 75	40 - 280	H894 * - 075 - †	H895 * - 075 - †	H896 * - 075 - †						
	10 - 100	50 - 380	H894 * - 100 - †	H895 * - 100 - †	H896 * - 100 - †						
	10 - 150	50 - 560	H894 * - 150 - †	H895 * - 150 - †	H896 * - 150 - †						
1 1/2" SAE 24	3 - 30	10 - 110	H864 * - 030 - †	H865 * - 030 - †	H866 * - 030 - †	A	B	5000 PSI S	F1/F2	MR	
	5 - 50	20 - 190	H864 * - 050 - †	H865 * - 050 - †	H866 * - 050 - †						
	10 - 75	40 - 280	H864 * - 075 - †	H865 * - 075 - †	H866 * - 075 - †						
	10 - 100	50 - 380	H864 * - 100 - †	H865 * - 100 - †	H866 * - 100 - †						
	10 - 150	50 - 560	H864 * - 150 - †	H865 * - 150 - †	H866 * - 150 - †						

① Fractional sizes apply to NPTF and BSPP.

(example) H 795 A - 030 - F1 or F2



Flow-Alert Flow Switches

F1 = Single Switch
F2 = Double Switch

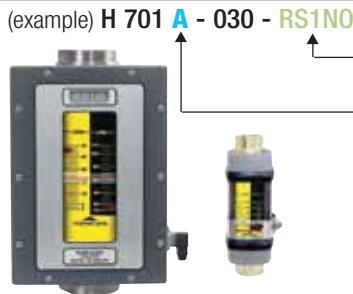

(example) H 701 A - 030 - RS1NO

Flow-Alert Reed Switches

Options:

RS1NO (reed switch one (1) normally open)
RS2NO (reed switch two (2) normally open)
RS1NC (reed switch one (1) normally closed)
RS2NC (reed switch two (2) normally closed)

(example) H 795 A - 030 - MR



Multiple Output Flow Sensor

3 Standard field selectable outputs

0-5 VDC } Flow Transmitter is factory-calibrated to provide 4 mA (0 VDC) at zero flow
0-10 VDC } and 20 mA (5/10 VDC) at full flow. Optional 5-point calibration certificate available
4-20 mA } (see Price and Availability Digest for details).

NOTE: 1/4" liquid meters for .02-0.2 and .05-0.5 GPM ranges available in strap-on design for RS1NO and RS1NC only.

NOTE: For 50% and 100% flow/pressure drop information, see page 24. For detailed flow/pressure drop charts, see page 62.

Flow-Alert Flow Switches and Flow Transmitters For Water-based Fluids (Water/Oil Emulsions)

ORDERING INFORMATION:

NOMINAL PORT SIZE ^①	FLOW RANGE		MODEL NUMBER (see example below)			MATERIAL			OPTIONS		
	GPM	LPM	SAE	NPTF	BSPP	ALUMINUM 3500 PSI	BRASS 3500 PSI	STAINLESS	Flow-Alert 1 SWITCH / 2 SWITCH	Flow-Alert REED SWITCH	MULTIPLE OUTPUT SENSOR
¼" SAE 6	.02 - 0.2	0.1 - 0.75	H212 * - 002 - †	H213 * - 002 - †	H214 * - 002 - †	A	B	6000 PSI S	Not Available		Not Available
	.05 - 0.5	0.2 - 1.9	H212 * - 005 - †	H213 * - 005 - †	H214 * - 005 - †						
¼" SAE 6	0.1 - 1.0	0.5 - 3.75	H212 * - 010 - †	H213 * - 010 - †	H214 * - 010 - †	A	B	6000 PSI S	F1/F2		MR
	0.2 - 2.0	1.0 - 7.5	H212 * - 020 - †	H213 * - 020 - †	H214 * - 020 - †						
½" SAE 10	0.1 - 1.0	0.5 - 3.75	H612 * - 001 - †	H613 * - 001 - †	H614 * - 001 - †	A	B	6000 PSI S	F1/F2		MR
	0.2 - 2.0	1 - 7.5	H612 * - 002 - †	H613 * - 002 - †	H614 * - 002 - †						
	0.5 - 5.0	2 - 19	H612 * - 005 - †	H613 * - 005 - †	H614 * - 005 - †						
	1 - 10	5 - 38	H612 * - 010 - †	H613 * - 010 - †	H614 * - 010 - †						
	1 - 15	4 - 56	H612 * - 015 - †	H613 * - 015 - †	H614 * - 015 - †						
¾" SAE 12	0.2 - 2.0	1 - 7.5	H712 * - 002 - †	H713 * - 002 - †	H714 * - 002 - †	A	B	5000 PSI S	F1/F2		MR
	0.5 - 5.0	2 - 19	H712 * - 005 - †	H713 * - 005 - †	H714 * - 005 - †						
	1 - 10	5 - 38	H712 * - 010 - †	H713 * - 010 - †	H714 * - 010 - †						
	2 - 20	10 - 76	H712 * - 020 - †	H713 * - 020 - †	H714 * - 020 - †						
	3 - 30	10 - 115	H712 * - 030 - †	H713 * - 030 - †	H714 * - 030 - †						
1" SAE 16	0.2 - 2.0	1 - 7.5	H782 * - 002 - †	H783 * - 002 - †	H784 * - 002 - †	A	B	5000 PSI S	F1/F2		MR
	0.5 - 5.0	2 - 19	H782 * - 005 - †	H783 * - 005 - †	H784 * - 005 - †						
	1 - 10	5 - 38	H782 * - 010 - †	H783 * - 010 - †	H784 * - 010 - †						
	2 - 20	10 - 76	H782 * - 020 - †	H783 * - 020 - †	H784 * - 020 - †						
	3 - 30	10 - 115	H782 * - 030 - †	H783 * - 030 - †	H784 * - 030 - †						
	4 - 40	15 - 150	H782 * - 040 - †	H783 * - 040 - †	H784 * - 040 - †						
	5 - 50	20 - 190	H782 * - 050 - †	H783 * - 050 - †	H784 * - 050 - †						
	5 - 50	20 - 190	H782 * - 050 - †	H783 * - 050 - †	H784 * - 050 - †						
1¼" SAE 20	3 - 30	10 - 110	H812 * - 030 - †	H813 * - 030 - †	H814 * - 030 - †	A	B	5000 PSI S	F1/F2		MR
	5 - 50	20 - 190	H812 * - 050 - †	H813 * - 050 - †	H814 * - 050 - †						
	10 - 75	40 - 280	H812 * - 075 - †	H813 * - 075 - †	H814 * - 075 - †						
	10 - 100	50 - 380	H812 * - 100 - †	H813 * - 100 - †	H814 * - 100 - †						
	10 - 150	50 - 560	H812 * - 150 - †	H813 * - 150 - †	H814 * - 150 - †						
1½" SAE 24	3 - 30	10 - 110	H882 * - 030 - †	H883 * - 030 - †	H884 * - 030 - †	A	B	5000 PSI S	F1/F2		MR
	5 - 50	20 - 190	H882 * - 050 - †	H883 * - 050 - †	H884 * - 050 - †						
	10 - 75	40 - 280	H882 * - 075 - †	H883 * - 075 - †	H884 * - 075 - †						
	10 - 100	50 - 380	H882 * - 100 - †	H883 * - 100 - †	H884 * - 100 - †						
	10 - 150	50 - 560	H882 * - 150 - †	H883 * - 150 - †	H884 * - 150 - †						

① Fractional sizes apply to NPTF and BSPP.

(example) H 713 A - 030 - F1 or F2



Flow-Alert Flow Switches

F1 = Single Switch
F2 = Double Switch

(example) H 701 A - 030 - RS1NO



Flow-Alert Reed Switches

Options:

RS1NO (reed switch one (1) normally open)
RS2NO (reed switch two (2) normally open)
RS1NC (reed switch one (1) normally closed)
RS2NC (reed switch two (2) normally closed)

(example) H 713 A - 030 - MR



Multiple Output Flow Sensor

3 Standard field selectable outputs

0-5 VDC } Flow Transmitter is factory-calibrated to provide 4 mA (0 VDC) at zero flow
0-10 VDC } and 20 mA (5/10 VDC) at full flow. Optional 5-point calibration certificate available
4-20 mA } (see Price and Availability Digest for details).

NOTE: ¼" liquid meters for .02-0.2 and .05-0.5 GPM ranges available in strap-on design for RS1NO and RS1NC only.

NOTE: For 50% and 100% flow/pressure drop information, see page 32. For detailed flow/pressure drop charts, see page 63.

Flow-Alert Flow Switches and Flow Transmitters For Water Fluids

ORDERING INFORMATION:

NOMINAL PORT SIZE [ⓐ]	FLOW RANGE		MODEL NUMBER (see example below)			MATERIAL		OPTIONS		
	GPM	LPM	SAE	NPTF	BSPP	BRASS 3500 PSI	STAINLESS	Flow-Alert 1 SWITCH / 2 SWITCH	Flow-Alert REED SWITCH	MULTIPLE OUTPUT SENSOR
¼" SAE 6	.02 - 0.2	0.1 - 0.75	H204 * - 002 - †	H205 * - 002 - †	H206 * - 002 - †	B	S	6000 PSI	Not Available	Not Available
	.05 - 0.5	0.2 - 1.9	H204 * - 005 - †	H205 * - 005 - †	H206 * - 005 - †					
¼" SAE 6	0.1 - 1.0	0.5 - 3.75	H204 * - 010 - †	H205 * - 010 - †	H206 * - 010 - †	B	S	6000 PSI	F1/F2	MR
	0.2 - 2.0	1.0 - 7.5	H204 * - 020 - †	H205 * - 020 - †	H206 * - 020 - †					
½" SAE 10	0.1 - 1.0	0.5 - 3.75	H604 * - 001 - †	H605 * - 001 - †	H606 * - 001 - †	B	S	6000 PSI	F1/F2	MR
	0.2 - 2.0	1 - 7.5	H604 * - 002 - †	H605 * - 002 - †	H606 * - 002 - †					
	0.5 - 5.0	2 - 19	H604 * - 005 - †	H605 * - 005 - †	H606 * - 005 - †					
	1 - 10	5 - 38	H604 * - 010 - †	H605 * - 010 - †	H606 * - 010 - †					
	1 - 15	4 - 56	H604 * - 015 - †	H605 * - 015 - †	H606 * - 015 - †					
¾" SAE 12	0.2 - 2.0	1 - 7.5	H704 * - 002 - †	H705 * - 002 - †	H706 * - 002 - †	B	S	5000 PSI	F1/F2	MR
	0.5 - 5.0	2 - 19	H704 * - 005 - †	H705 * - 005 - †	H706 * - 005 - †					
	1 - 10	5 - 38	H704 * - 010 - †	H705 * - 010 - †	H706 * - 010 - †					
	2 - 20	10 - 76	H704 * - 020 - †	H705 * - 020 - †	H706 * - 020 - †					
	3 - 30	10 - 115	H704 * - 030 - †	H705 * - 030 - †	H706 * - 030 - †					
1" SAE 16	0.2 - 2.0	1 - 7.5	H754 * - 002 - †	H755 * - 002 - †	H756 * - 002 - †	B	S	5000 PSI	F1/F2	MR
	0.5 - 5.0	2 - 19	H754 * - 005 - †	H755 * - 005 - †	H756 * - 005 - †					
	1 - 10	5 - 38	H754 * - 010 - †	H755 * - 010 - †	H756 * - 010 - †					
	2 - 20	10 - 76	H754 * - 020 - †	H755 * - 020 - †	H756 * - 020 - †					
	3 - 30	10 - 115	H754 * - 030 - †	H755 * - 030 - †	H756 * - 030 - †					
1¼" SAE 20	3 - 30	10 - 110	H804 * - 030 - †	H805 * - 030 - †	H806 * - 030 - †	B	S	5000 PSI	F1/F2	MR
	5 - 50	20 - 190	H804 * - 050 - †	H805 * - 050 - †	H806 * - 050 - †					
	10 - 75	40 - 280	H804 * - 075 - †	H805 * - 075 - †	H806 * - 075 - †					
	10 - 100	50 - 380	H804 * - 100 - †	H805 * - 100 - †	H806 * - 100 - †					
	10 - 150	50 - 560	H804 * - 150 - †	H805 * - 150 - †	H806 * - 150 - †					
1½" SAE 24	3 - 30	10 - 110	H854 * - 030 - †	H855 * - 030 - †	H856 * - 030 - †	B	S	5000 PSI	F1/F2	MR
	5 - 50	20 - 190	H854 * - 050 - †	H855 * - 050 - †	H856 * - 050 - †					
	10 - 75	40 - 280	H854 * - 075 - †	H855 * - 075 - †	H856 * - 075 - †					
	10 - 100	50 - 380	H854 * - 100 - †	H855 * - 100 - †	H856 * - 100 - †					
	10 - 150	50 - 560	H854 * - 150 - †	H855 * - 150 - †	H856 * - 150 - †					

ⓐ Fractional sizes apply to NPTF and BSPP.

(example) H 705 B - 030 - F1 or F2



Flow-Alert Flow Switches

F1 = Single Switch
F2 = Double Switch

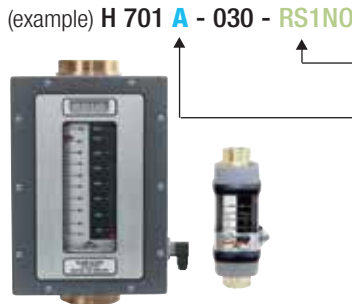

(example) H 701 A - 030 - RS1NO

Flow-Alert Reed Switches

Options:

- RS1NO (reed switch one (1) normally open)
- RS2NO (reed switch two (2) normally open)
- RS1NC (reed switch one (1) normally closed)
- RS2NC (reed switch two (2) normally closed)

(example) H 705 B - 030 - MR



Multiple Output Flow Sensor

3 Standard field selectable outputs

0-5 VDC } Flow Transmitter is factory-calibrated to provide 4 mA (0 VDC) at zero flow
0-10 VDC } and 20 mA (5/10 VDC) at full flow. Optional 5-point calibration certificate available
4-20 mA } (see Price and Availability Digest for details).

NOTE: ¼" liquid meters for .02-0.2 and .05-0.5 GPM ranges available in strap-on design for RS1NO and RS1NC only.

NOTE: For 50% and 100% flow/pressure drop information, see page 36. For detailed flow/pressure drop charts, see page 64.

Flow-Alert Flow Switches and Flow Transmitters For API Oil / Caustic and Corrosive Liquids

ORDERING INFORMATION:

NOMINAL PORT SIZE	FLOW RANGE		MODEL NUMBER (see example below)				OPTIONS		
	GPM	LPM	API - OIL .876 (S.G.)		LIQUIDS 1.0 (S.G.)		Flow-Alert 1 SWITCH / 2 SWITCH	Flow-Alert REED SWITCH	MULTIPLE OUTPUT SENSOR
			NPTF	BSPP	NPSF	BSPP			
1/4"	0.1 - 1.0	0.5 - 3.75	6000 PSI H231X - 010 - †	6000 PSI H232X - 010 - †	6000 PSI H234X - 010 - †	6000 PSI H235X - 010 - †	Not Available	SEE OPTIONS BELOW	Not Available
1/4"	0.2 - 2.0	1 - 7.5	6000 PSI H231X - 020 - †	6000 PSI H232X - 020 - †	6000 PSI H234X - 020 - †	6000 PSI H235X - 020 - †	F1/F2		MR
1/2"	0.2 - 2.0	1 - 7.5	6000 PSI H631X - 002 - †	6000 PSI H632X - 002 - †	6000 PSI H634X - 002 - †	6000 PSI H635X - 002 - †	F1/F2		MR
	0.5 - 5.0	2 - 19	H631X - 005 - †	H632X - 005 - †	H634X - 005 - †	H635X - 005 - †			
	1 - 10	5 - 38	H631X - 010 - †	H632X - 010 - †	H634X - 010 - †	H635X - 010 - †			
	1 - 15	4 - 56	H631X - 015 - †	H632X - 015 - †	H634X - 015 - †	H635X - 015 - †			
3/4"	0.2 - 2.0	1 - 7.5	5000 PSI H731X - 002 - †	5000 PSI H732X - 002 - †	5000 PSI H734X - 002 - †	5000 PSI H735X - 002 - †	F1/F2		MR
	0.5 - 5.0	2 - 19	H731X - 005 - †	H732X - 005 - †	H734X - 005 - †	H735X - 005 - †			
	1 - 10	5 - 38	H731X - 010 - †	H732X - 010 - †	H734X - 010 - †	H735X - 010 - †			
	2 - 20	10 - 76	H731X - 020 - †	H732X - 020 - †	H734X - 020 - †	H735X - 020 - †			
	3 - 30	10 - 115	H731X - 030 - †	H732X - 030 - †	H734X - 030 - †	H735X - 030 - †			
1"	0.2 - 2.0	1 - 7.5	5000 PSI H741X - 002 - †	5000 PSI H742X - 002 - †	5000 PSI H744X - 002 - †	5000 PSI H745X - 002 - †	F1/F2	MR	
	0.5 - 5.0	2 - 19	H741X - 005 - †	H742X - 005 - †	H744X - 005 - †	H745X - 005 - †			
	1 - 10	5 - 38	H741X - 010 - †	H742X - 010 - †	H744X - 010 - †	H745X - 010 - †			
	2 - 20	10 - 76	H741X - 020 - †	H742X - 020 - †	H744X - 020 - †	H745X - 020 - †			
	3 - 30	10 - 115	H741X - 030 - †	H742X - 030 - †	H744X - 030 - †	H745X - 030 - †			
	4 - 40	15 - 150	H741X - 040 - †	H742X - 040 - †	H744X - 040 - †	H745X - 040 - †			
1 1/4"	3 - 30	10 - 110	5000 PSI H831X - 030 - †	5000 PSI H832X - 030 - †	5000 PSI H834X - 030 - †	5000 PSI H835X - 030 - †	F1/F2	MR	
	5 - 50	20 - 190	H831X - 050 - †	H832X - 050 - †	H834X - 050 - †	H835X - 050 - †			
	10 - 75	40 - 280	H831X - 075 - †	H832X - 075 - †	H834X - 075 - †	H835X - 075 - †			
	10 - 100	50 - 380	H831X - 100 - †	H832X - 100 - †	H834X - 100 - †	H835X - 100 - †			
1 1/2"	3 - 30	10 - 110	5000 PSI H841X - 030 - †	5000 PSI H842X - 030 - †	5000 PSI H844X - 030 - †	5000 PSI H845X - 030 - †	F1/F2	MR	
	5 - 50	20 - 190	H841X - 050 - †	H842X - 050 - †	H844X - 050 - †	H845X - 050 - †			
	10 - 75	40 - 280	H841X - 075 - †	H842X - 075 - †	H844X - 075 - †	H845X - 075 - †			
	10 - 100	50 - 380	H841X - 100 - †	H842X - 100 - †	H844X - 100 - †	H845X - 100 - †			

(example) H 734 X - 030 - F1 or F2



Flow-Alert Flow Switches

F1 = Single Switch
F2 = Double Switch

(example) H 734 X - 030 - RS1NO



Flow-Alert Reed Switches

Options:

- RS1NO (reed switch one (1) normally open)
- RS2NO (reed switch two (2) normally open)
- RS1NC (reed switch one (1) normally closed)
- RS2NC (reed switch two (2) normally closed)

(example) H 734 X - 030 - MR



Multiple Output Flow Sensor

3 Standard field selectable outputs
0-5 VDC
0-10 VDC
4-20 mA

Flow Transmitter is factory-calibrated to provide 4 mA (0 VDC) at zero flow and 20 mA (5/10 VDC) at full flow.
Optional 5-point calibration certificate available (see Price and Availability Digest for details).

NOTE: 1/4" liquid meters for 0.1-1.0 GPM range available in strap-on design for RS1NO and RS1NC only.

NOTE: For 50% and 100% flow/pressure drop information, see page 38. For detailed pressure drop charts, see page 65 for API Oil and page 64 for Water and Other Liquids.

Flow-Alert Flow Switches and Flow Transmitters For Air / Caustic and Corrosive Gases

ORDERING INFORMATION:

NOMINAL PORT SIZE	FLOW RANGE		MODEL NUMBER (see example below)		OPTIONS		
	SCFM	L/SEC	GASES 1.0 (S.G.)		Flow-Alert 1 SWITCH / 2 SWITCH	Flow-Alert REED SWITCH	MULTIPLE OUTPUT SENSOR
			NPTF	BSPP			
¼"	20-20	1-9	H237X - 020 - †	H238X - 020 - †	Not Available	SEE O P T I O N S	Not Available
	30-30	1.5-14	H237X - 030 - †	H238X - 030 - †			
¼"	3-25	2-12	H237X - 025 - †	H238X - 025 - †	F1/F2	B E L O W	MR
	5-50	3-22	H237X - 050 - †	H238X - 050 - †			
½"	3-25	2-12	H637X - 025 - †	H638X - 025 - †	F1/F2	B E L O W	MR
	5-50	3-22	H637X - 050 - †	H638X - 050 - †			
	10-100	5-47	H637X - 100 - †	H638X - 100 - †			
	15-150	7-70	H637X - 150 - †	H638X - 150 - †			
¾"	3-25	1.5-11.5	H737X - 025 - †	H738X - 025 - †	F1/F2	B E L O W	MR
	5-50	2-23	H737X - 050 - †	H738X - 050 - †			
	10-100	5-47.5	H737X - 100 - †	H738X - 100 - †			
	15-150	7-70	H737X - 150 - †	H738X - 150 - †			
	25-250	10-118	H737X - 250 - †	H738X - 250 - †			
1"	3-25	1.5-11.5	H747X - 025 - †	H748X - 025 - †	F1/F2	B E L O W	MR
	5-50	2-23	H747X - 050 - †	H748X - 050 - †			
	10-100	5-47.5	H747X - 100 - †	H748X - 100 - †			
	15-150	7-70	H747X - 150 - †	H748X - 150 - †			
	25-250	10-118	H747X - 250 - †	H748X - 250 - †			
1¼"	20-200	10-95	H837X - 200 - †	H838X - 200 - †	F1/F2	B E L O W	MR
	40-400	20-180	H837X - 400 - †	H838X - 400 - †			
	60-600	30-280	H837X - 600 - †	H838X - 600 - †			
	80-800	50-350	H837X - 800 - †	H838X - 800 - †			
1½"	20-200	10-95	H847X - 200 - †	H848X - 200 - †	F1/F2	B E L O W	MR
	40-400	20-180	H847X - 400 - †	H848X - 400 - †			
	60-600	30-280	H847X - 600 - †	H848X - 600 - †			
	80-800	50-350	H847X - 800 - †	H848X - 800 - †			

(example) H 737 X - 250 - F1 or F2



Flow-Alert Flow Switches

F1 = Single Switch
F2 = Double Switch

(example) H 737 X - 250 - RS1NO



Flow-Alert Reed Switches

Options:

- RS1NO (reed switch one (1) normally open)
- RS2NO (reed switch two (2) normally open)
- RS1NC (reed switch one (1) normally closed)
- RS2NC (reed switch two (2) normally closed)

NOTE: ¼" air meters for 2.0-20 and 3.0-30 SCFM ranges available in strap-on design for RS1NO and RS1NC only.

(example) H 737 X - 250 - MR



Multiple Output Flow Sensor

3 Standard field selectable outputs

- 0-5 VDC
 - 0-10 VDC
 - 4-20 mA
- } Flow Transmitter is factory-calibrated to provide 4 mA (0 VDC) at zero flow and 20 mA (5/10 VDC) at full flow. Optional 5-point calibration certificate available (see Price and Availability Digest for details).



CAUTION: High flow gas shock may decouple indicator.

NOTE: For 50% and 100% flow/pressure drop information, see page 40. For detailed flow/pressure drop charts, see page 65.

Flow-Alert Flow Switches and Flow Transmitters

For Air / Compressed Gases

ORDERING INFORMATION:

NOMINAL PORT SIZE ^①	FLOW RANGE		MODEL NUMBER (see example below)			MATERIAL			OPTIONS		
	SCFM	L/SEC	SAE	NPTF	BSPP	ALUMINUM 1000 PSI	BRASS 1000 PSI	STAINLESS 1500 PSI	Flow-Alert 1 SWITCH / 2 SWITCH	Flow-Alert REED SWITCH	MULTIPLE OUTPUT SENSOR
¼" SAE 6	0.5 - 5	0.2 - 2.2	H270 * - 005 - †	H271 * - 005 - †	H272 * - 005 - †	A	B	S	Not Available	SEE OPTIONS BELOW	Not Available
	1 - 10	0.5 - 4.75	H270 * - 010 - †	H271 * - 010 - †	H272 * - 010 - †						
	2 - 20	1 - 9	H270 * - 020 - †	H271 * - 020 - †	H272 * - 020 - †						
	3 - 30	1.5 - 14	H270 * - 030 - †	H271 * - 030 - †	H272 * - 030 - †						
¼" SAE 6	3 - 25	2 - 12	H270 * - 025 - †	H271 * - 025 - †	H272 * - 025 - †	A	B	S	F1/F2	SEE OPTIONS BELOW	MR
	5 - 50	3 - 22	H270 * - 050 - †	H271 * - 050 - †	H272 * - 050 - †						
½" SAE 10	3 - 25	2 - 12	H670 * - 025 - †	H671 * - 025 - †	H672 * - 025 - †	A	B	S	F1/F2	SEE OPTIONS BELOW	MR
	5 - 50	3 - 22	H670 * - 050 - †	H671 * - 050 - †	H672 * - 050 - †						
	10 - 100	5 - 47	H670 * - 100 - †	H671 * - 100 - †	H672 * - 100 - †						
	15 - 150	7 - 70	H670 * - 150 - †	H671 * - 150 - †	H672 * - 150 - †						
¾" SAE 12	3 - 25	1.5 - 11.5	H770 * - 025 - †	H771 * - 025 - †	H772 * - 025 - †	A	B	S	F1/F2	SEE OPTIONS BELOW	MR
	5 - 50	2 - 23	H770 * - 050 - †	H771 * - 050 - †	H772 * - 050 - †						
	10 - 100	5 - 47.5	H770 * - 100 - †	H771 * - 100 - †	H772 * - 100 - †						
	15 - 150	7 - 70	H770 * - 150 - †	H771 * - 150 - †	H772 * - 150 - †						
	25 - 250	10 - 118	H770 * - 250 - †	H771 * - 250 - †	H772 * - 250 - †						
1" SAE 16	3 - 25	1.5 - 11.5	H790 * - 025 - †	H791 * - 025 - †	H792 * - 025 - †	A	B	S	F1/F2	SEE OPTIONS BELOW	MR
	5 - 50	2 - 23	H790 * - 050 - †	H791 * - 050 - †	H792 * - 050 - †						
	10 - 100	5 - 47.5	H790 * - 100 - †	H791 * - 100 - †	H792 * - 100 - †						
	15 - 150	7 - 70	H790 * - 150 - †	H791 * - 150 - †	H792 * - 150 - †						
	25 - 250	10 - 118	H790 * - 250 - †	H791 * - 250 - †	H792 * - 250 - †						
1¼" SAE 20	20 - 200	10 - 95	H870 * - 200 - †	H871 * - 200 - †	H872 * - 200 - †	A	B	S	F1/F2	SEE OPTIONS BELOW	MR
	40 - 400	20 - 180	H870 * - 400 - †	H871 * - 400 - †	H872 * - 400 - †						
	60 - 600	30 - 280	H870 * - 600 - †	H871 * - 600 - †	H872 * - 600 - †						
	80 - 800	50 - 350	H870 * - 800 - †	H871 * - 800 - †	H872 * - 800 - †						
	100 - 1000	50 - 475	H870 * - 999 - †	H871 * - 999 - †	H872 * - 999 - †						
1½" SAE 24	20 - 200	10 - 95	H890 * - 200 - †	H891 * - 200 - †	H892 * - 200 - †	A	B	S	F1/F2	SEE OPTIONS BELOW	MR
	40 - 400	20 - 180	H890 * - 400 - †	H891 * - 400 - †	H892 * - 400 - †						
	60 - 600	30 - 280	H890 * - 600 - †	H891 * - 600 - †	H892 * - 600 - †						
	80 - 800	50 - 350	H890 * - 800 - †	H891 * - 800 - †	H892 * - 800 - †						
	100 - 1000	50 - 475	H890 * - 999 - †	H891 * - 999 - †	H892 * - 999 - †						

① Fractional sizes apply to NPTF and BSPP.

(example) H 771 A - 250 - F1 or F2



Flow-Alert Flow Switches

F1 = Single Switch
F2 = Double Switch

(example) H 701 A - 030 - RS1NO



Flow-Alert Reed Switches

Options:

- RS1NO (reed switch one (1) normally open)
- RS2NO (reed switch two (2) normally open)
- RS1NC (reed switch one (1) normally closed)
- RS2NC (reed switch two (2) normally closed)

(example) H 771 A - 250 - MR



Multiple Output Flow Sensor

3 Standard field selectable outputs

0-5 VDC } Flow Transmitter is factory-calibrated to provide 4 mA (0 VDC) at zero flow
0-10 VDC } and 20 mA (5/10 VDC) at full flow. Optional 5-point calibration certificate available
4-20 mA } (see Price and Availability Digest for details).

NOTE: ¼" air meters for .05-5, 1-10, 2-20 and 3-30 SCFM ranges available in strap-on design for RS1NO and RS1NC only.



CAUTION: High flow gas shock may decouple indicator.

NOTE: For 50% and 100% flow/pressure drop information, see page 40. For detailed flow/pressure drop charts, see page 66.

Digital Display

For Hedland® MR Flow Transmitters

Applications

- Remote flow meter monitoring
- Totalizing
- Alarm processing
- Process control

Features

- 5-digit rate display
- 5-digit totalizer with 4-digit overcarry
- Input: 4-20 mA or 0-10 VDC
- Built-in transmitter power supply
- Three plug-in card slots
- Optional setpoint alarm cards
- AC and DC powered versions
- NEMA 4X/IP65 rated



Introduction

The F6700/F6750 series digital display with integrated signal processor accepts a 4-20 mA or 0-10 VDC signal from Hedland's MR Flow Transmitters as well as any other 4-20 mA or 0-10 VDC source.

These 5-digit displays can be scaled to most engineering units and are easily programmed using the front panel buttons or available programming software. To meet your specific requirements, each display accepts up to three optional plug-in cards. One card for each of the following function types can be installed in each display:

Analog Outputs – A linear DC output signal card will be set up to provide either 4-20 mA, 0-20 mA or 0-10 VDC signals and can be scaled independent of the input range.

Communications – Optional plug-in cards to facilitate digital communications include: RS232, RS485, Modbus, Profibus and DeviceNet.

Setpoint Alarms – Select from dual FORM-C relays (5 Amp), quad FORM-A relays (3 Amp) or either sinking or sourcing quad open collector logic outputs.

The analog output and communication cards will be installed by the factory at time of order, or they may be installed by the customer at a later date. The setpoint alarm cards are available for customer installation and setup only.

SPECIFICATIONS:

Display:	5-digit, 0.56" sunlight-readable red LED
Power:	
AC	85 to 250 VAC, 50/60 Hz, 15 VA
DC	11 to 36 VDC, 11 W
A/D Converter:	16-bit resolution
A/D Conversion Rate:	20 readings/sec
Display Update Rate:	1 to 20 updates/sec
Sensor Inputs:	4-20 mA or 0-10 VDC
Transmitter Power:	24 VDC, $\pm 5\%$, regulated 50 mA maximum
Totalizer Time Base:	Second, minute, hour or day
Total:	9 digits, display alternates between high order and low order readouts
Linearization Data	
Point Pairs:	Selectable from 2 to 16
Operating Temperature:	32 °F to 122 °F (0 °C to 50 °C) (32 °F to 113 °F with all three plug-in cards installed)

Digital Display

For Hedland® MR Flow Transmitters

Ordering Information

Power Version	Display	Analog Output		Communications		Display Units	
AC	F6700	4-20 mA	- A	RS232	- A	GPM	- G
DC	F6750	0-20 mA	- B	RS485	- B	LPM	- L
		0-10 VDC	- C	Modbus	- C	SCFM	- S
		None	- X	Profibus	- D	LPS	- T
				DeviceNet	- E		
				None	- X		

Note: Select one option from each category

Ordering Examples:

F6700-X-X-G = AC powered, displays GPM

F6700-A-A-L = AC powered + 4-20 mA Out + RS232, displays LPM

F6750-C-X-S = DC powered + 0-10 VDC Out, displays SCFM

Form C Relay Plug-in Option Card

Part Number F6542

This optional plug-in card requires customer installation and setup. To facilitate setup, it is recommended that this feature be utilized with a display that includes a serial communication card (RS232 or RS485) and programming software.

NOTE: For additional setpoint alarm options, consult factory for information.

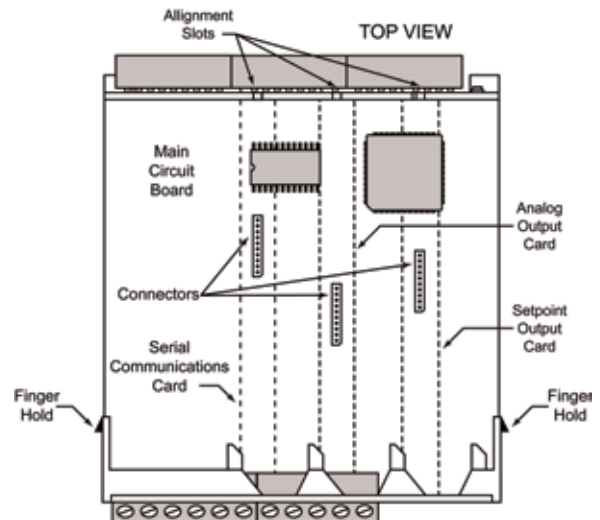

Dimensions:

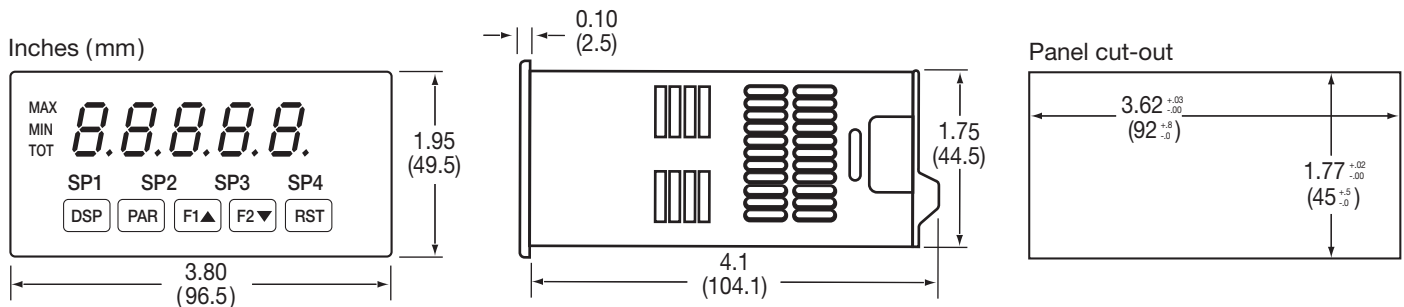

Flow vs. Pressure Drop

Petroleum Fluids

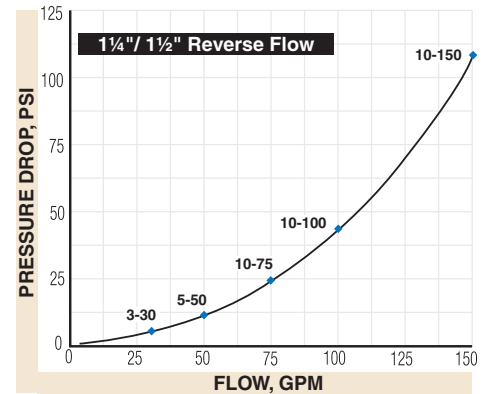
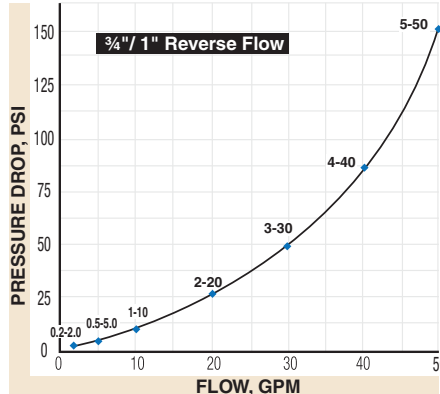
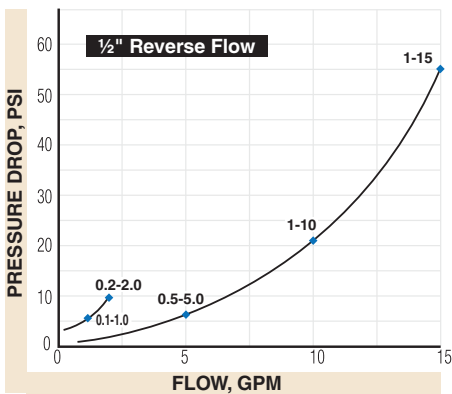
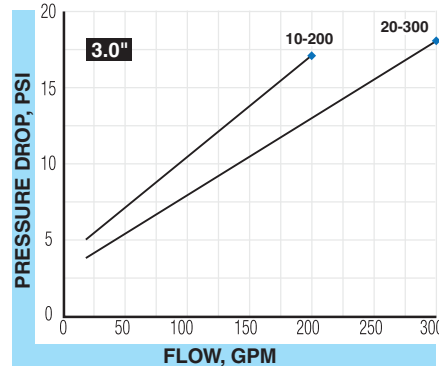
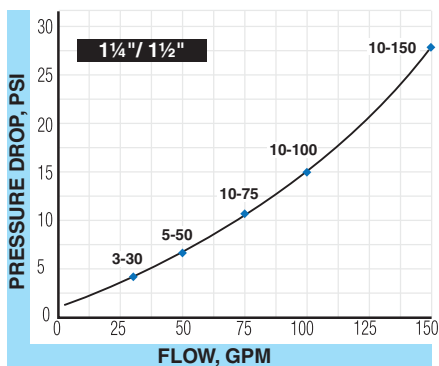
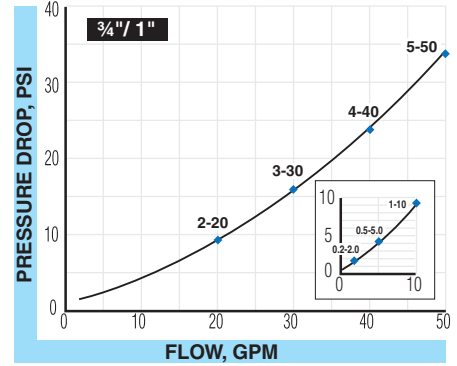
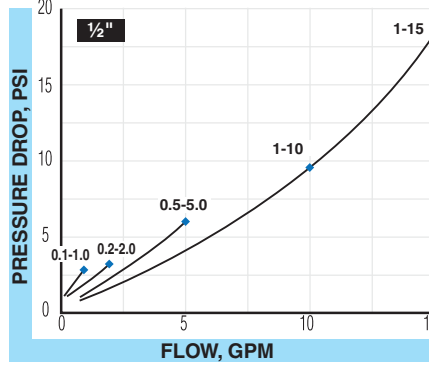
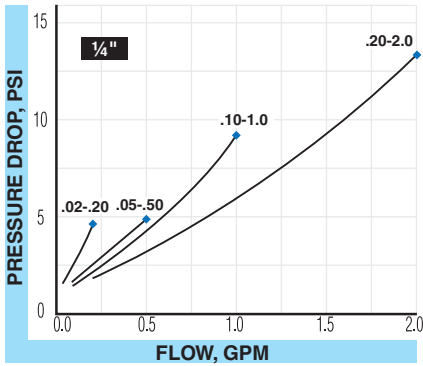

Petroleum Test Kits

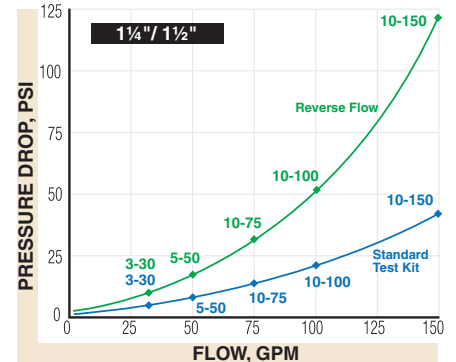
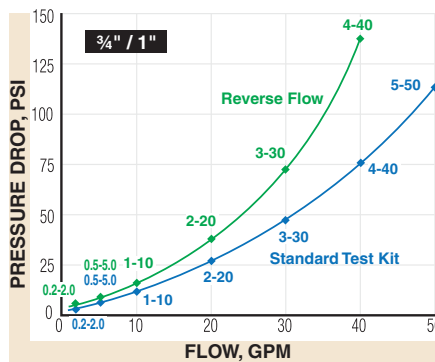
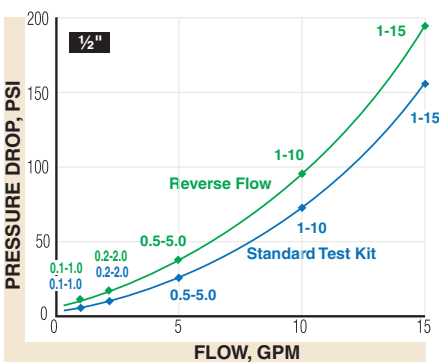

Flow vs. Pressure Drop

Phosphate Ester

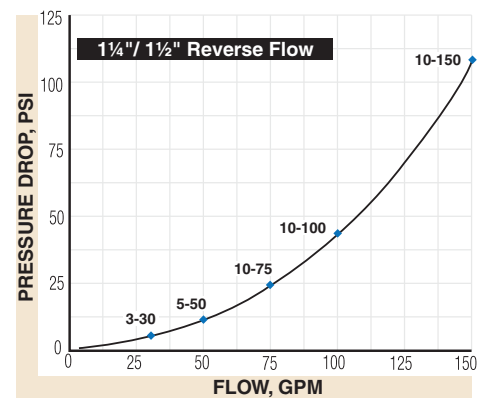
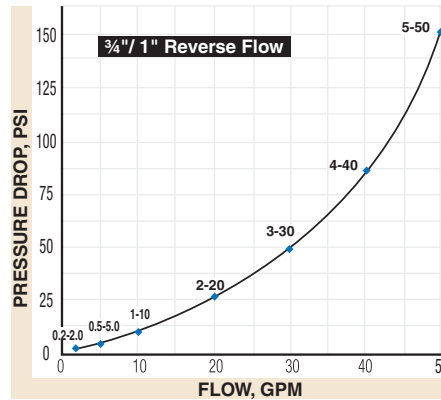
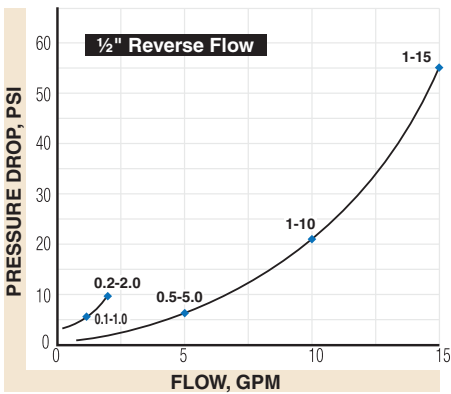
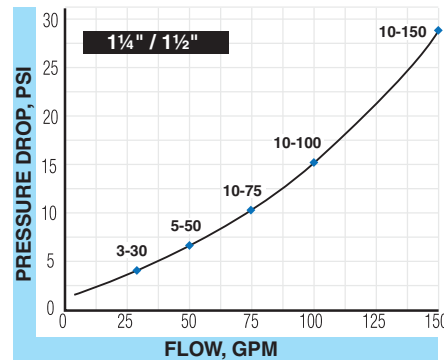
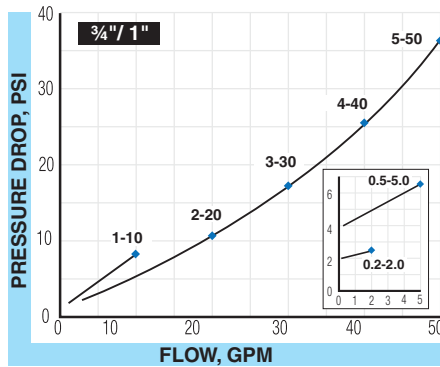
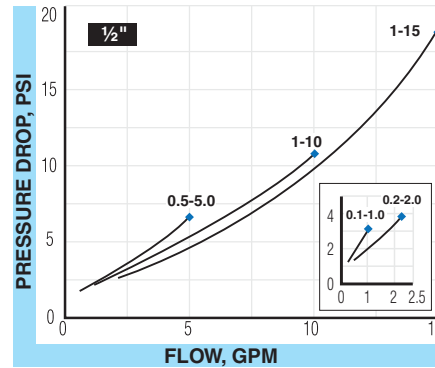
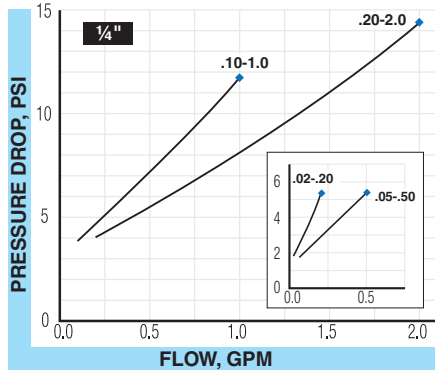

Phosphate Ester Test Kits

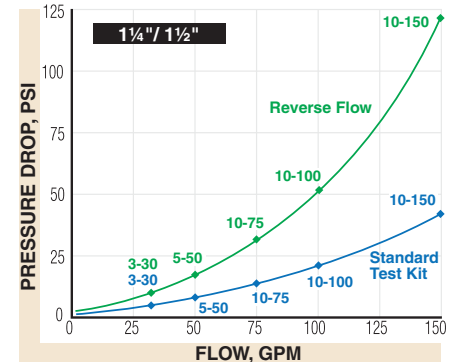
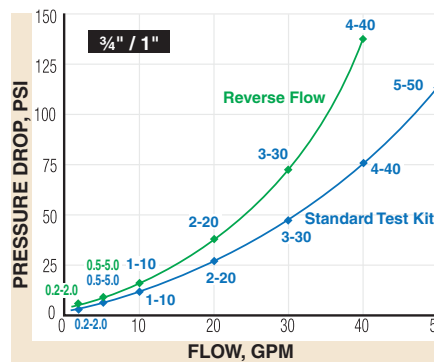
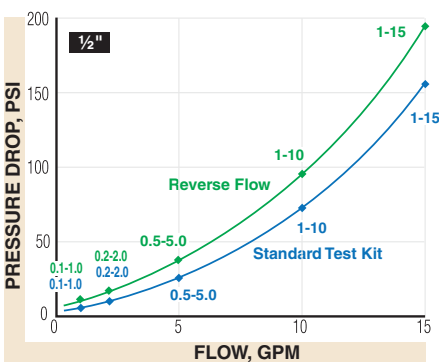

Flow vs. Pressure Drop

Water - based Fluids

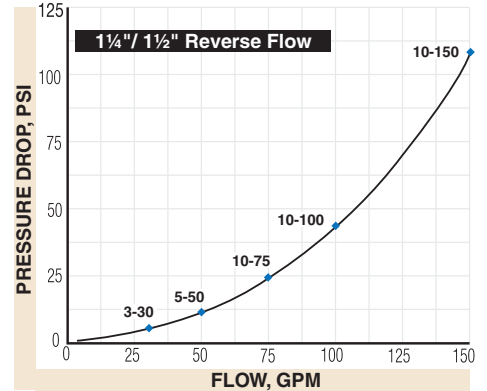
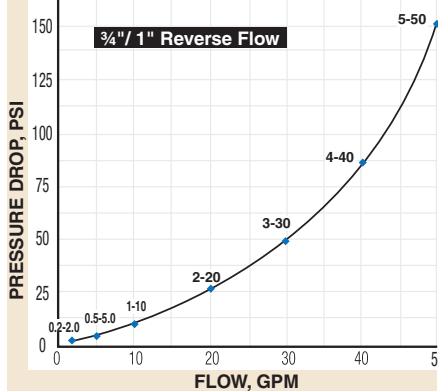
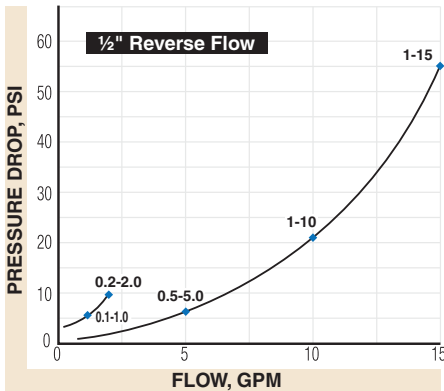
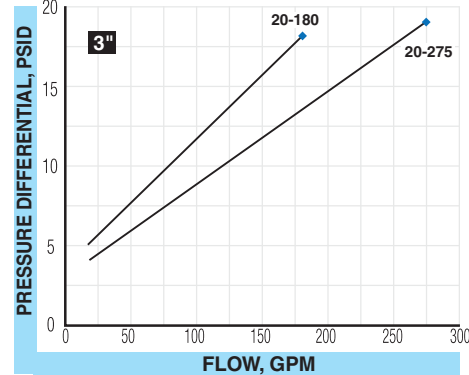
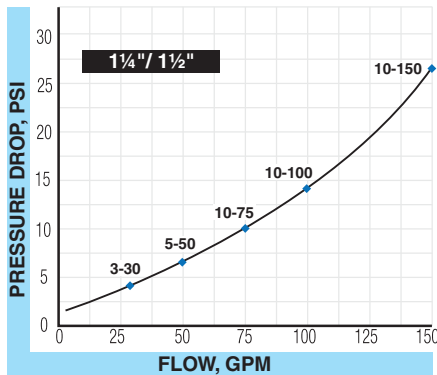
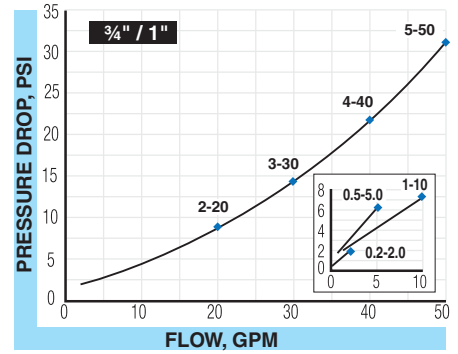
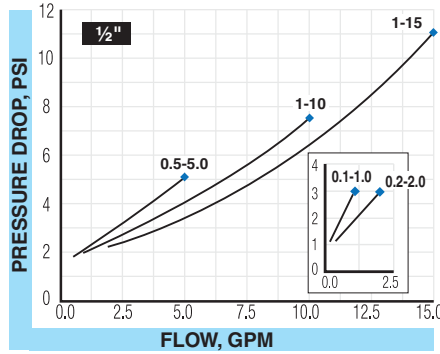
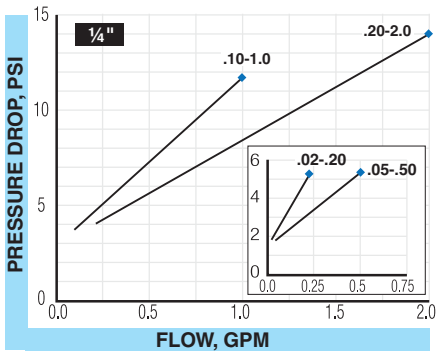

Water - based Fluid Test Kits

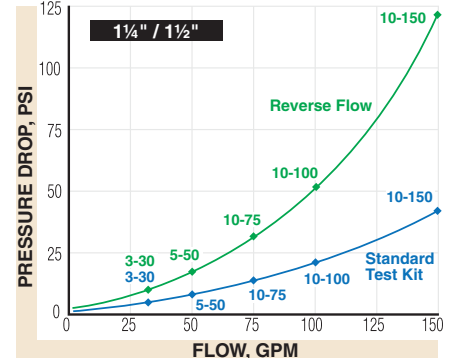
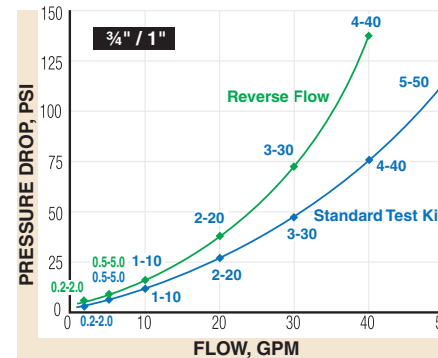
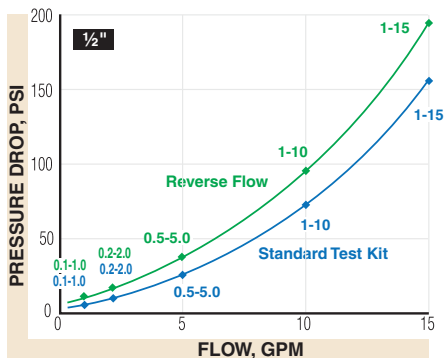

Flow vs. Pressure Drop

Water

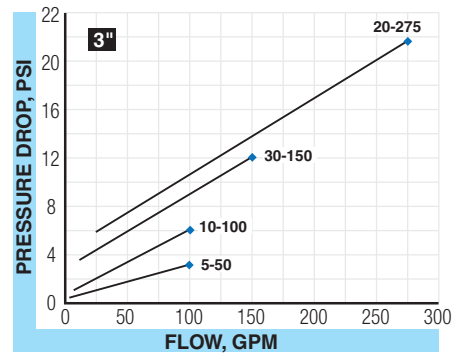
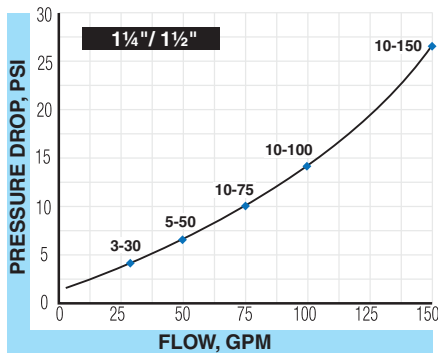
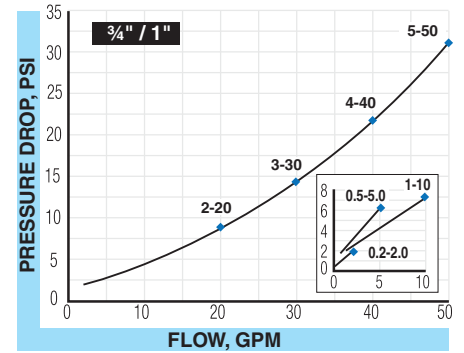
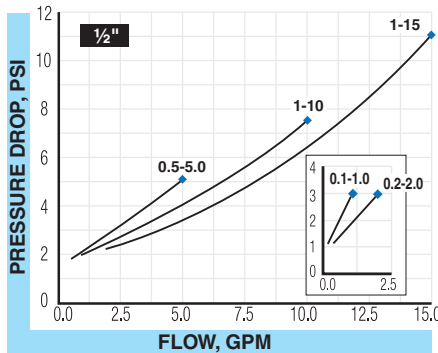
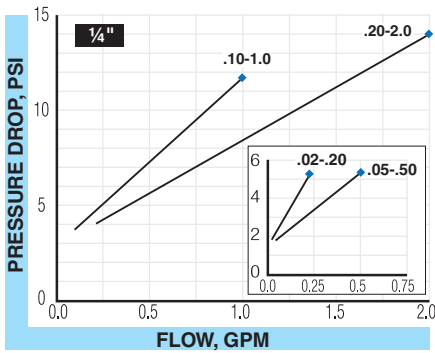

Caustic and Corrosive Liquids

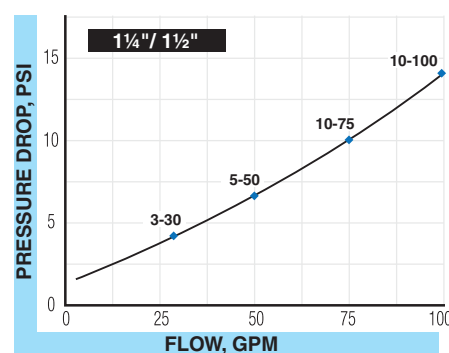
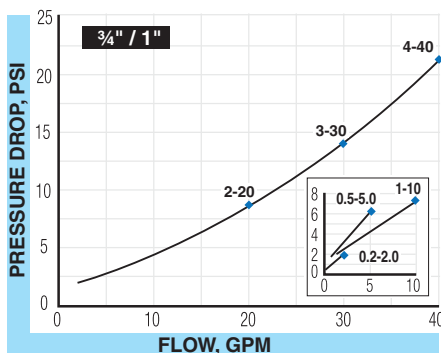
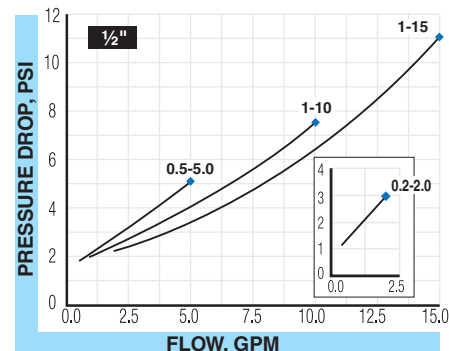
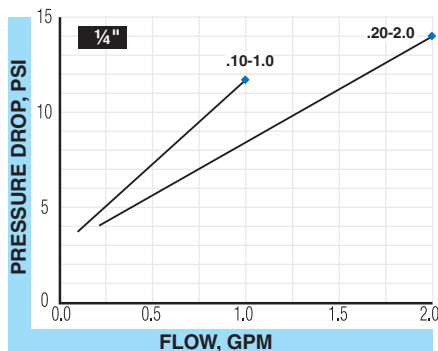

Flow vs. Pressure Drop

A.P.I. Oil

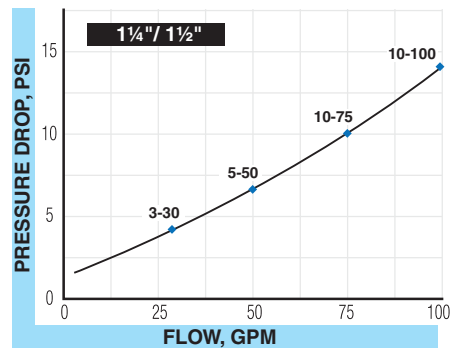
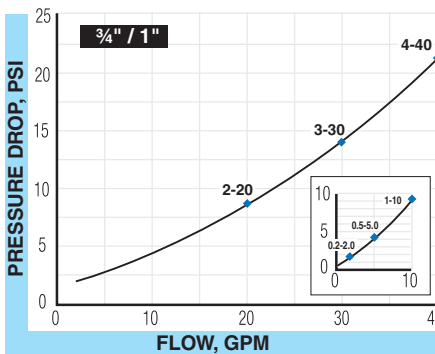
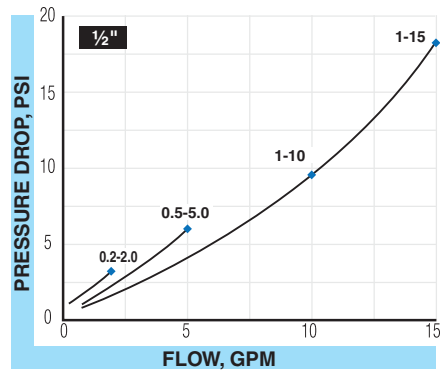
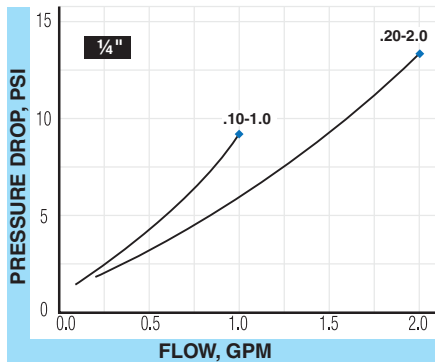

Air / Caustic and Corrosive Gases

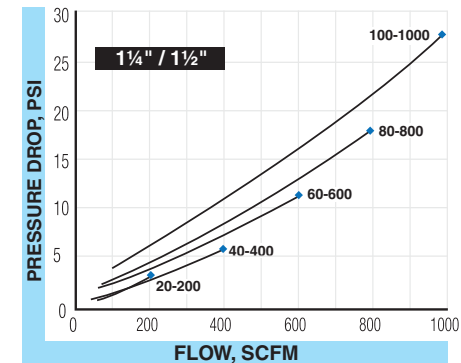
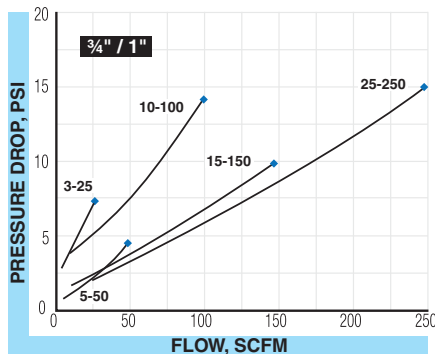
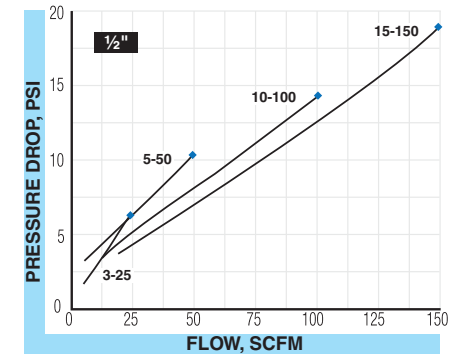
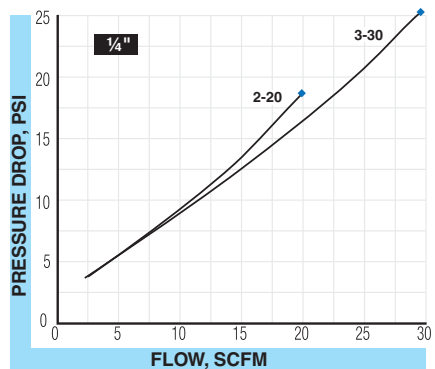

Flow vs. Pressure Drop

Air / Compressed Gases

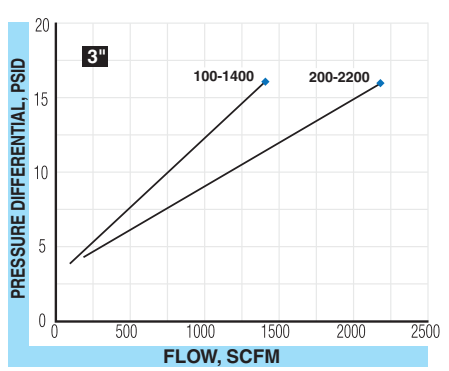
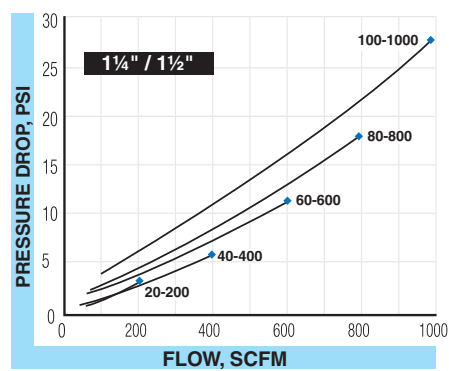
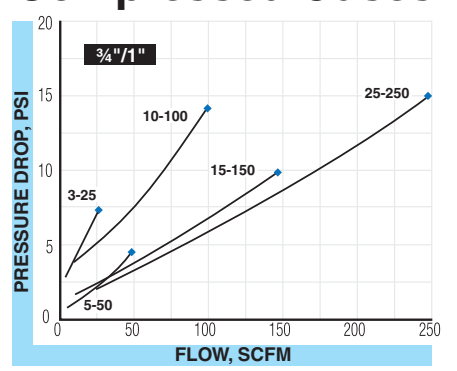
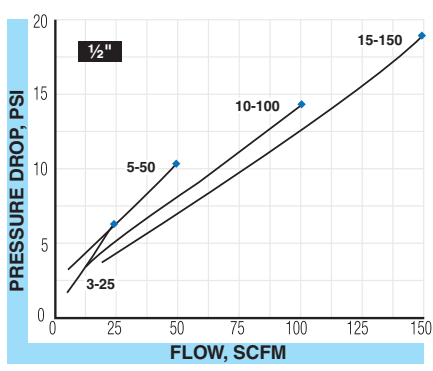
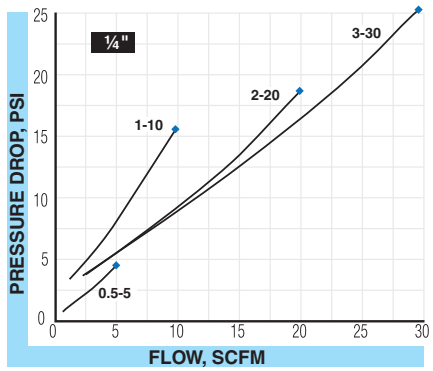

Air / Compressed Gas Test Kits

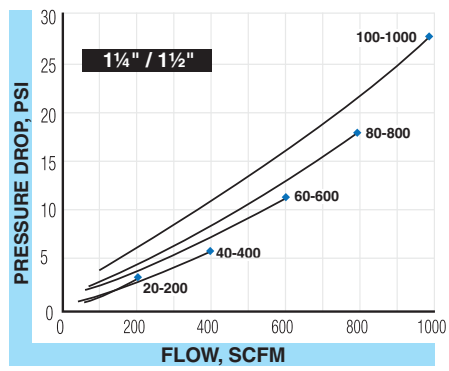
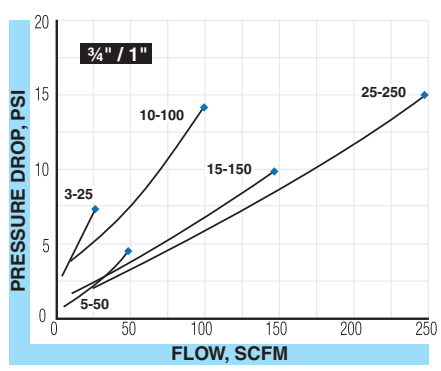
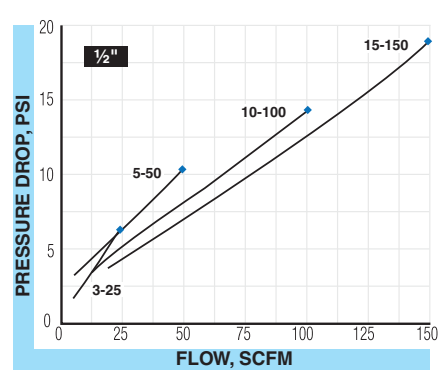
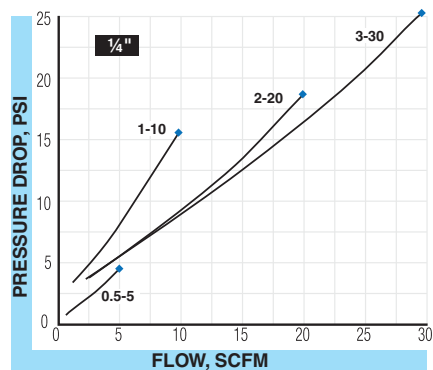

EZ-View® Flow Meters

General Design Features

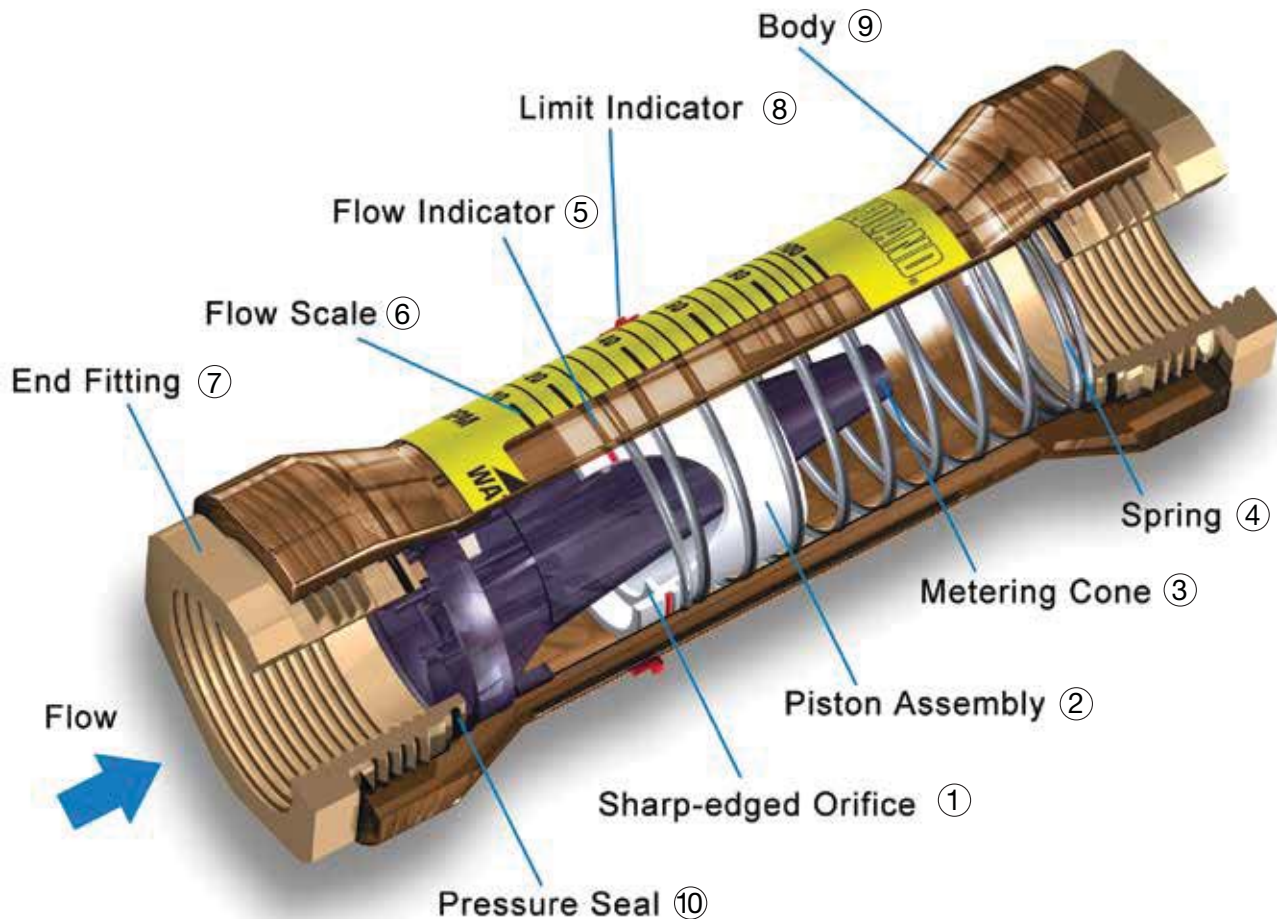

OPERATING PRINCIPLE

The EZ-View Flow Meter is a variable area instrument. A precision-molded, sharp-edged Orifice (1), located within the Piston Assembly (2) forms an annular opening with the Metering Cone (3). Flow through the meter creates a pressure differential across the sharp-edged orifice, moving the piston against the Spring (4). The piston moves precisely, in direct proportion to the rate of flow. The calibrated spring opposes flow in the forward direction. This spring decreases viscosity sensitivity and allows the flow meters to be used in any position, including inverted. The indicated flow rate is measured by viewing the red Flow Indicator (5) line on the piston relative to the precalibrated numerical scale, mounted on the outer surface of the transparent flow meter body.

NOTE: The piston assembly carries a cylindrical magnet on all EZ-View Flow-Alert™ models. This magnet is necessary to activate the AC, DC or Reed switch modules when flow conditions are too high or too low.

Operates in any position: The Hedland in-line flow meter's unique spring loaded variable area design allows meters to be installed in any position without effecting accuracy. It can be installed into horizontal or vertical lines, or with an optional inverted flow scale, this meter can monitor flow in a downward flowing (i.e. gravity feed) line.

Easy-to-read scale: This flow meter is the most readable product in its class. A brightly colored Flow Scale (6) contains bold, easy-to-read numerals and gauge marks. This enhanced resolution virtually eliminates parallax problems associated with competitive, direct reading flow meters.

Accuracy within ±5% full scale: The EZ-View Flow Meter accuracy is within ±5% of full scale while monitoring liquids with viscosity and specific gravity similar to factory calibrated fluids.

Repeatability within ±1%: This is particularly important in cyclical applications, which require consistent readings.

Operating Temperature: Maximum operating temperature is 250 °F (121 °C).

Operating Pressure: Maximum operating pressure is 325 psi/22.4 bar.

Rugged Construction: Flow meters are available in brass, stainless, and PVC fittings, with NPT or BSP ports (see Ordering Information Tables). Constructed of high-impact polysulfone plastic, this simple variable area flow meter contains a minimum number of moving parts, offering a reliable, trouble-free flow rate indicator to monitor a wide range of liquids and gases.

Note: Inlet and outlet pipe supports are recommended to prevent breakage.

EZ-View® Flow Meters

General Design Features

No flow straighteners or special piping: The Hedland design does not require special plumbing or accessories to stabilize turbulent flow. Flow meters can be installed immediately adjacent to 90-degree elbows or other components providing system design flexibility.

Filtration: Although Hedland flow meters are more contamination tolerant than most fluid system components, 200 mesh (74 micron) or better filtration is required to assure reliable performance.

Standard flow scales:

Standard flow scales are calibrated in gallons per minute (gpm) and liters per minute (lpm) at 0.876 specific gravity for petroleum-based fluids, 1.0 specific gravity for water and water-based emulsions.

Special flow scales: Special scales are available in any measurement unit and/or specific gravity.

Viscosity Effect (SUS/cSt): Hedland's design utilizes a precision-molded, sharp-edged orifice and biasing calibration spring that ensures operating stability and accuracy over the wide viscosity range common to many fluids. Generally, high flow models provide good accuracy over a viscosity range of 40 to 500 SUS (4.2 to 108 cSt).

Density Effect (specific gravity): Any fluid density change from stated standards has a square-root effect on meter accuracy. Special scales can be supplied if actual specific gravity decreases accuracy beyond application limits.

Corrections for more or less dense fluids can be made to standard scales using correction equations. Refer to pages 4-6.

Fluid Selection Chart

Fluid	Specific Gravity	Correction Factor of Standard Scale		Internal Components				Fittings		
				Polysulfone	T300 Stainless Spring	Buna N	PH15 7 MO Stainless Retaining Ring	C360 Brass	PVC - Type 1	T303 Stainless
Acetic Acid (Air Free)	1.06	0.909	0.971	R	R	C	R	N	R	R
Acetone	0.79	1.053	1.125	N	R	N	R	R	N	R
Alcohol Butyl (Butanol)	0.83	1.027	1.098	R	R	R	R	C	R	R
Alcohol Ethyl (Ethanol)	0.83	1.027	1.098	R	R	N	R	C	R	R
Ammonia	0.89	0.992	1.060	R	R	C	R	C	R	R
Benzene	0.69	1.127	1.204	N	N	N	N	R	N	N
Carbon Disulphide	1.26	0.834	0.891	N	R	N	R	N	N	R
Castor Oil	0.97	0.950	1.015	C	C	R	C	R	C	C
Cotton Seed Oil	0.93	0.970	1.037	R	R	R	R	R	N	R
Ethylene Glycol 50/50	1.12	0.884	0.945	R	R	R	R	R	R	R
Freon II	1.46	0.774	0.828	N	R	N	R	R	N	R
Gasoline	0.70	1.119	1.195	R	R	R	R	R	C	R
Glycerin	1.26	0.834	0.891	R	R	R	R	R	R	R
Kerosene	0.82	1.033	1.104	R	R	R	R	R	R	R
Liquid Propane (LPG)	0.51	1.310	1.400	N	R	R	R	R	R	R
Mineral Oil	0.92	0.976	1.042	R	R	R	R	R	R	R
Naphtha	0.76	1.074	1.147	N	R	R	R	N	N	R
Perchloroethylene	1.62	0.735	0.786	N	R	R	R	N	N	R
Petroleum Oil	0.876	1.000	1.068	R	R	R	R	R	R	R
Phosphate Ester	1.18	0.862	0.921	N	R	N	R	R	N	R
Phosphate Ester Base	1.26	0.833	0.891	N	R	N	R	R	N	R
Phosphoric Acid (Air Free)	1.78	0.701	0.749	R	N	C	N	N	R	N
Sea Water	1.03	0.922	0.985	R	N	R	N	N	R	N
Synthetic Petroleum Base	1.00	0.936	1.000	R	R	R	R	C	R	R
Water	1.00	0.936	1.000	R	R	R	R	R	R	R
Water Glycol 50/50	1.07	0.905	0.967	R	R	R	R	R	R	R
Water-in-oil	0.93	0.970	1.037	R	R	R	R	R	R	R

R – Recommended N – Not Recommended C – Consult Factory

EZ-View® Flow Meters

For Oil and Water

- ½ to 1 inch ports
- EZ to install, in any position
- Polysulfone bodies for standard applications or Radel® R for more aggressive media
- No special piping or flow straighteners needed
- No electrical connections
- Direct reading indication
- Accuracy within 5% full scale
- Relatively insensitive to shock and vibration

SPECIFICATIONS:

MATERIALS:

Polysulfone plastic body, piston and cone
Radel® R plastic body and cone, polysulfone piston

COMMON PARTS:

Spring: T300-series stainless

Indicator Ring: Buna N

Pressure Seals: Buna N

Fittings: C360 brass, PVC, or T303 stainless steel

Limit Indicators: Polypropylene

Retaining Ring: PH15 – 7MO stainless

OPTIONAL (consult factory):

Spring and Retaining Ring: Teflon® coated

FITTINGS/ THREADS: NPT ANSI/ASME B1.20.1, BSPT ISOR7

See Ordering Information Table, page 70

TEMPERATURE RANGE: +32 °F to +250 °F (0 °C to +121 °C)

PRESSURE RATING: 325 psi / 22.4 bar maximum

PRESSURE DROP: See Differential Pressure Charts, page 64

ACCURACY: ±5% of full scale

REPEATABILITY: ±1%

DIMENSIONS: See Ordering Information Table, page 70



EZ-View with Polysulfone body



EZ-View with Radel® R body

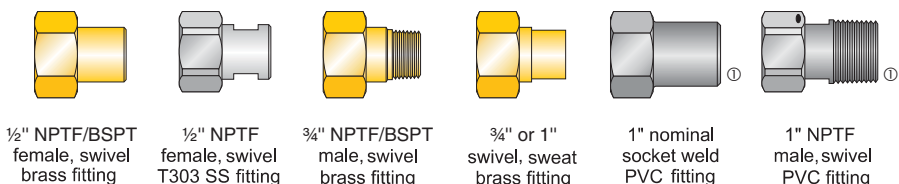
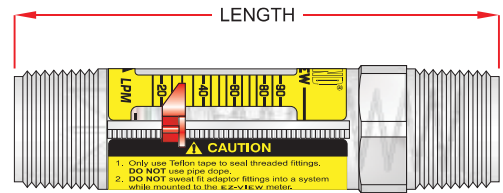
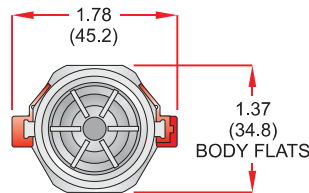

① Meters with Type 1 PVC fittings:

Pressure rating per normal PVC system specifications
Temperature range +32 °F to +140 °F (0 °C to +60 °C)

Teflon is a registered trademark of E.I. DuPont de Nemours & Co.
Radel is a registered trademark of Union Carbide Corporation.

EZ-View® Flow Meters

For Oil and water

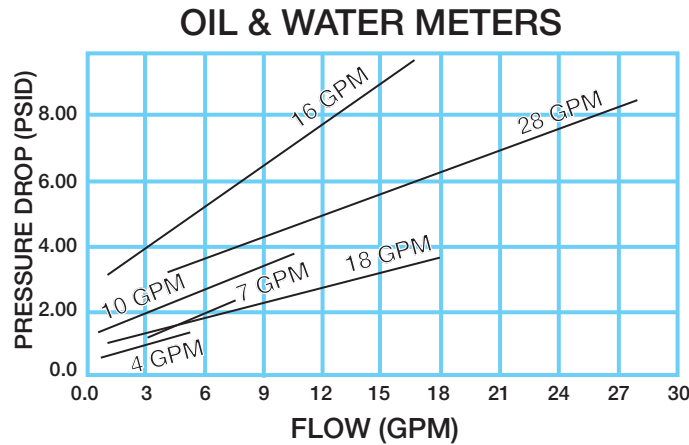

Ordering Information

Fluid Media	Flow Range		½" NPTF female, swivel brass fitting	½" NPTF female, swivel T303 SS fitting	½" BSPT female, swivel brass fitting	¾" NPTF male, swivel brass fitting	¾" BSPT male, swivel brass fitting	¾" or 1" ① nominal, swivel sweat brass fitting	1" NPTF ② male, plastic polysulfone fitting	1" nominal ③ socket weld PVC fitting	1" NPTF male, swivel PVC fitting	Material	
	GPM	LPM										Polysulfone	Radel R
Oil 0.876 s.g.	0.5 - 4	2 - 15	H624-104	H626-104	H627-104	H625-104	H630-104		H621-104	H628-104	H629-104	STD	-R
	1.0 - 7	4 - 26	H624-107	H626-107	H627-107	H625-107	H630-107		H621-107	H628-107	H629-107		
	1.0 - 10	4 - 35	H624-110	H626-110	H627-110	H625-110	H630-110		H621-110	H628-110	H629-110		
	1.0 - 16	5 - 60	H624-116	H626-116	H627-116	H625-116	H630-116		H621-116	H628-116	H629-116		
	3.0 - 18	15 - 65				H625-118	H630-118		H621-118	H628-118	H629-118		
	4.0 - 28	20 - 100				H625-128	H630-128		H621-128	H628-128	H629-128		
Water 1.0 s.g.	0.5 - 4	2 - 15	H624-004	H626-004	H627-004	H625-004	H630-004	H620-004	H621-004	H628-004	H629-004	STD	-R
	1.0 - 7	4 - 26	H624-007	H626-007	H627-007	H625-007	H630-007	H620-007	H621-007	H628-007	H629-007		
	1.0 - 10	4 - 35	H624-010	H626-010	H627-010	H625-010	H630-010	H620-010	H621-010	H628-010	H629-010		
	1.0 - 16	5 - 60	H624-016	H626-016	H627-016	H625-016	H630-016	H620-016	H621-016	H628-016	H629-016		
	3.0 - 18	15 - 65				H625-018	H630-018	H620-018	H621-018	H628-018	H629-018		
	4.0 - 28	20 - 100				H625-028	H630-028	H620-028	H621-028	H628-028	H629-028		
DIMENSIONS:													
	Length ④ in (mm)		7.75 (196.8)	7.75 (196.8)	7.75 (196.8)	8.25 (209.5)	8.25 (209.5)	7.75 (196.8)	5.25 (133.3)	8.46 (214.9)	8.86 (225.0)		
	Fitting Flats in (mm)		1.50 (38.1)	1.50 (38.1)	1.50 (38.1)	1.50 (38.1)	1.50 (38.1)	1.50 (38.1)	N/A	1.54 (39.1)	1.50 (38.1)		
	Weight lb (kg)		0.95 (0.43)	0.85 (0.39)	0.95 (0.43)	0.90 (0.41)	0.90 (0.41)	0.75 (0.34)	0.20 (0.09)	0.35 (0.16)	0.55 (0.25)		

- ① Fits ¾" copper tube types K, L, M; 1" copper tube type M only
- ② DO NOT use pipe dope. Use Teflon® tape only. Use with plastic fittings only.
- ③ Fits 1" Sch 40/80 PVC, CPVC pipe. Requires 1" pipe coupling.
- ④ Length includes end fittings.

(example) Polysulfone Model = **H 624 - 104**
 Radel® R Model = **H 624 - 104 -R**

EZ-View® Flow Meters

With Flow-Alert Flow Switch

- Reed switch and latching models
- Automatically signals alarm if flow is too high or too low
- Models available for AC or DC power supply
- Latching models include Hirschmann type electrical connector
- Polysulfone bodies for standard applications or Radel® R for more aggressive media
- Easy to install
- Easy flow limit adjustment
- Operates in any position
- Relatively insensitive to shock and vibration
- Repeatability within $\pm 1\%$
- Low cost

SPECIFICATIONS:

MATERIALS:

Polysulfone plastic body, piston and cone

Radel® R plastic body and cone, polysulfone piston

COMMON PARTS:

Spring: T300-series stainless

Indicator Ring: Buna N

Pressure Seals: Buna N

Fittings: C360 Brass, PVC, or T303 stainless steel

Limit Indicators: Polypropylene

Magnet: Strontium Ferrite

Retaining Ring: PH15 – 7MO stainless

FITTINGS/ THREADS: NPT ANSI/ASME B1.20.1, BSPT ISOR7

See Ordering Information Table, page 72

TEMPERATURE RANGE: +32 °F to +250 °F (0 °C to +121 °C)

PRESSURE RATING: 325 psi / 22.4 bar maximum

PRESSURE DROP: See Differential Pressure Chart, page 72

ACCURACY: $\pm 5\%$ of full scale

REPEATABILITY: $\pm 1\%$

DIMENSIONS: See Ordering Information Table, page 72



EZ-View with Polysulfone body



EZ-View with Radel® R body

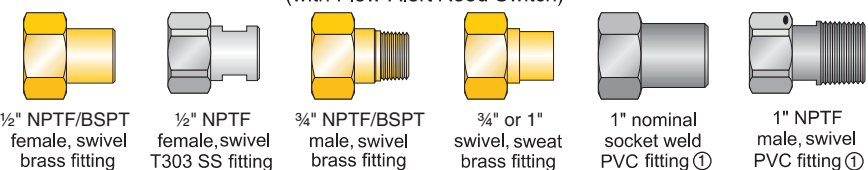
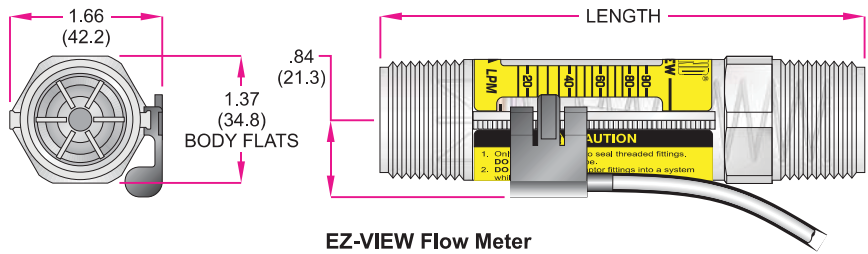
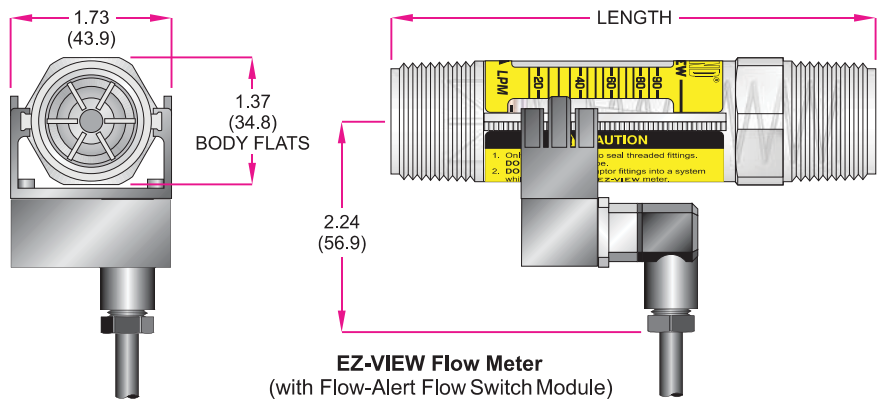

- ① Meters with Type 1 PVC fittings:
 Pressure rating per normal PVC system specifications
 Temperature range +32 °F to +140 °F (0 °C to +60 °C)

Teflon is a registered trademark of E.I. DuPont de Nemours & Co. Radel is a registered trademark of Union Carbide Corporation.

EZ-View® Flow Meters

With Flow-Alert Flow Switch

Flow Switch Options and Specifications:

The AC and DC powered Flow-Alert Flow Switch modules consist of a latching relay circuit housed in a sealed polypropylene enclosure. The modules have a normally open dry relay contact that can be used to directly control alarms, warning lights, relays or be used to interface to a PLC. The relay will be latched on as the magnet inside the flow meter passes by the module, and remain latched on until the magnet passes in the other direction or power is interrupted. The set point is adjustable from 0 to 100% of full scale.

The Reed Switch Flow-Alert modules are housed in a sealed polypropylene enclosure. The reed switch module does not provide the latching function like the AC and DC powered units. When the magnet inside the flow meter comes within proximity of the module, the reed switch will change state. The set point is adjustable from 0 to 100% full scale. Two reed switches providing low flow and high flow set points may be installed on a single flow meter.

	AC Latching	DC Latching	Reed Switch Form-A Normally Open (NO)	Reed Switch Form-B Normally Closed (NC)	Reed Switch Form-C
Operating Voltage	115 VAC ±10%	10-30 VDC	–	–	–
Operating Current	25 mA maximum	25 mA maximum	–	–	–
Contact Rating	1A @ 30 VDC 0.5A @ 125 VAC Resistive Load	1A @ 30 VDC 0.5A @ 125 VAC Resistive Load	1A max 200 VDC max 15 Watts max Resistive Load	0.25A max 175 VDC max 5 Watts max Resistive Load	0.25A max 175 VDC max 5 Watts max Resistive Load
Operating Temperature	+32 to +158 °F (0 to +70 °C)	+32 to +158 °F (0 to +70 °C)	+32 to +250 °F (0 to +121 °C)	+32 to +250 °F (0 to +121 °C)	+32 to +250° F (0 to +121 °C)
Connector	4-pin connector (Protection Class IP65)	4-pin connector (Protection Class IP65)	–	–	–
Cable	Not Included	Not Included	3 foot, 2-wire #24 AWG black PVC Jacketed pig-tail	3 foot, 2-wire #20 AWG grey PVC Jacketed pig-tail	3 foot, 3-wire #24 AWG grey PVC Jacketed pig-tail
Rating	NEMA 12 & 13 (IP65)	NEMA 12 & 13 (IP65)	NEMA 12 & 13 (IP65)	NEMA 12 & 13 (IP65)	NEMA 12 & 13 (IP65)
Certification	N/A	EMC Directive 89/336/EEC	EMC Directive 89/336/EEC	EMC Directive 89/336/EEC	EMC Directive 89/336/EEC
Model Number	H526-003	H526-005	H526-008-NO	H526-008-NC	H526-008

NOTE: Flow switches and flow meters sold separately

Ordering Information

Fluid Media	Flow Range		½" NPTF female, swivel brass fitting	½" NPTF female, swivel T303 SS fitting	½" BSPT female, swivel brass fitting	¾" NPTF male, swivel brass fitting	¾" BSPT male, swivel brass fitting	¾" or 1" nominal, swivel sweat brass fitting	1" NPTF male, plastic polysulfone fitting	1" nominal socket weld PVC fitting	1" NPTF male, swivel PVC fitting	Material	
	GPM	LPM										Polysulfone	Radel R
Oil 0.876 s.g.	0.5 - 4	2 - 15	H624-704	H626-704	H627-704	H625-704	H630-704		H621-704	H628-704	H629-704	STD	-R
	1.0 - 7	4 - 26	H624-707	H626-707	H627-707	H625-707	H630-707		H621-707	H628-707	H629-707		
	1.0 - 10	4 - 35	H624-710	H626-710	H627-710	H625-710	H630-710		H621-710	H628-710	H629-710		
	1.0 - 16	5 - 60	H624-716	H626-716	H627-716	H625-716	H630-716		H621-716	H628-716	H629-716		
	3.0 - 18	15 - 65				H625-718	H630-718		H621-718	H628-718	H629-718		
	4.0 - 28	20 -100				H625-728	H630-728		H621-728	H628-728	H629-728		
Water 1.0 s.g.	0.5 - 4	2 - 15	H624-604	H626-604	H627-604	H625-604	H630-604	H620-604	H621-604	H628-604	H629-604	STD	-R
	1.0 - 7	4 - 26	H624-607	H626-607	H627-607	H625-607	H630-607	H620-607	H621-607	H628-607	H629-607		
	1.0 - 10	4 - 35	H624-610	H626-610	H627-610	H625-610	H630-610	H620-610	H621-610	H628-610	H629-610		
	1.0 - 16	5 - 60	H624-616	H626-616	H627-616	H625-616	H630-616	H620-616	H621-616	H628-616	H629-616		
	3.0 - 18	15 - 65				H625-618	H630-618	H620-618	H621-618	H628-618	H629-618		
	4.0 - 28	20 -100				H625-628	H630-628	H620-628	H621-628	H628-628	H629-628		
DIMENSIONS: Length ^④ in (mm) Fitting Flats in (mm) Weight lb (kg)			7.75 (196.8) 1.50 (38.1) 0.95 (0.43)	7.75 (196.8) 1.50 (38.1) 0.85 (0.39)	7.75 (196.8) 1.50 (38.1) 0.95 (0.43)	8.25 (209.5) 1.50 (38.1) 0.90 (0.41)	8.25 (209.5) 1.50 (38.1) 0.90 (0.41)	7.75 (196.8) 1.50 (38.1) 0.75 (0.34)	5.25 (133.3) N/A 0.20 (0.09)	8.46 (214.9) 1.54 (39.1) 0.35 (0.16)	8.86 (225.0) 1.50 (38.1) 0.55 (0.25)		

① Fits ¾" copper tube types K, L, M; 1" copper tube type M only

② DO NOT use pipe dope. Use Teflon® tape only. Use with plastic fittings only.

③ Fits 1" Sch 40/80 PVC, CPVC pipe. Requires 1" pipe coupling.

④ Length includes end fittings.

(example) Polysulfone Model = **H 624 - 704**
Radel® R Model = **H 624 - 704 -R**

EZ-View® Flow Meters

For Oil and Water

- 1½ to 2 inch ports
- No special piping or flow straighteners needed
- EZ to install, in any position
- No electrical connections
- Direct reading indication
- Accuracy within ±5% full scale
- Relatively insensitive to shock and vibration

SPECIFICATIONS:

MATERIALS:

Radel® R plastic body; polysulfone piston and cone
 T300-series stainless spring
 Buna N flow indicator ring and pressure seals
 C360 Brass or PVC fittings
 Polypropylene limit indicators

FITTINGS/ THREADS: NPT ANSI/ASME B1.20.1, BSPP ISO228

See Ordering Information Table, page 74

TEMPERATURE RANGE: +32 °F to +250 °F (0 °C to +121 °C)

PRESSURE RATING: 325 psi / 22.4 bar maximum

PRESSURE DROP: See Differential Pressure Chart, page 74

ACCURACY: ±5% of full scale

REPEATABILITY: ±1%

DIMENSIONS: See Ordering Information Table, page 74



EZ-View with Radel® R body

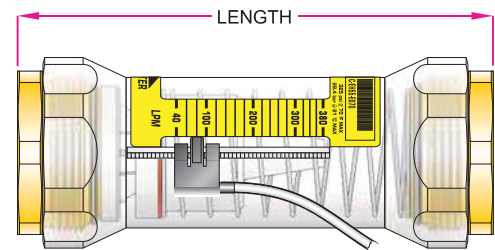
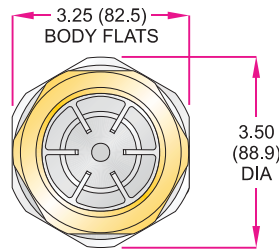

EZ-VIEW Flow Meter
(with Flow-Alert Reed Switch)

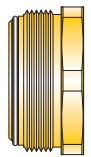

1½" NPTF female brass fitting



1½" BSPP female brass fitting



2" NPTF female brass fitting



2" BSPP female brass fitting

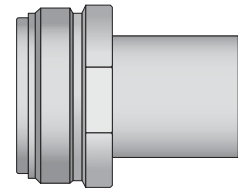

2" PVC socket weld fitting ①

① Meters with Type 1 PVC fittings:

Pressure rating per normal PVC system specifications

Temperature range +32 °F to +140 °F (0 °C to +60 °C)

EZ-View® Flow Meters

For Oil and Water

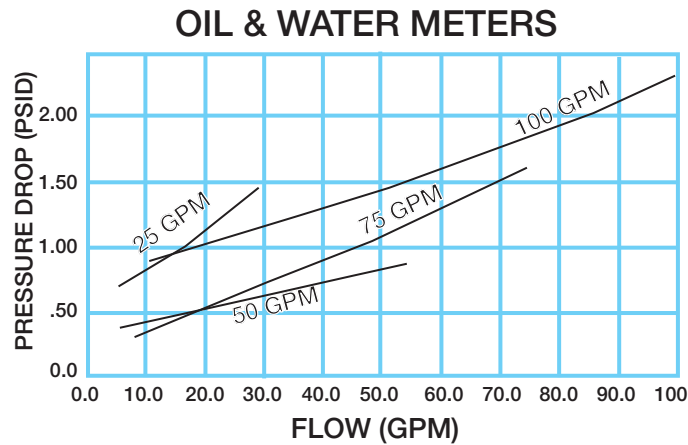

Ordering Information

Fluid Media	Flow Range		1½" NPTF female, brass fitting	1½" BSPP female, brass fitting	2" NPTF female, brass fitting	2" BSPP female, brass fitting	2" PVC socket weld fitting ^①
	GPM	LPM					
Oil 0.876 s.g.	2 – 25	10 – 95	H615-125-R	H616-125-R	H617-125-R	H618-125-R	
	5 – 50	20 – 190	H615-150-R	H616-150-R	H617-150-R	H618-150-R	
	7 – 75	30 – 280	H615-175-R	H616-175-R	H617-175-R	H618-175-R	
	10 – 100	40 – 380	H615-110-R	H616-110-R	H617-110-R	H618-110-R	
Water 1.0 s.g.	2 – 25	10 – 95	H615-025-R	H616-025-R	H617-025-R	H618-025-R	H619-025-R
	5 – 50	20 – 190	H615-050-R	H616-050-R	H617-050-R	H618-050-R	H619-050-R
	7 – 75	30 – 280	H615-075-R	H616-075-R	H617-075-R	H618-075-R	H619-075-R
	10 – 100	40 – 380	H615-010-R	H616-010-R	H617-010-R	H618-010-R	H619-010-R
DIMENSIONS:	Length ^② in (mm)		8.72 (221.5)	8.72 (221.5)	8.72 (221.5)	8.72 (221.5)	11.48 (291.6)
	Fitting Flats in (mm)		3.00 (76.2)	3.00 (76.2)	3.00 (76.2)	3.00 (76.2)	N/A
	Weight lb (kg)		4.10 (1.86)	4.10 (1.86)	3.10 (1.41)	3.10 (1.41)	1.70 (0.77)

① Fits 2" Sch 40/80 PVC, CPVC pipe.

② Length includes end fitting.

EZ-View® Flow Meters

With Flow-Alert Flow Switch

- Reed switch and latching models
- Automatically signals alarm, if flow is too high or too low
- Models available for AC or DC power supply
- Latching model includes Hirschmann type electrical connector
- Easy to install
- Easy flow limit adjustment
- Operates in any position
- Relatively insensitive to shock and vibration
- Repeatability within $\pm 1\%$
- Low cost

SPECIFICATIONS:

MATERIALS:

Radel® R plastic body; polysulfone piston and cone
 T300-series stainless spring
 Buna N flow indicator ring and pressure seals
 C360 Brass or PVC fittings
 Polypropylene limit indicators
 Strontium Ferrite magnet

FITTINGS/ THREADS: NPT ANSI/ASME B1.20.1, BSPP ISO228

See Ordering Information Table, page 76

TEMPERATURE RANGE: +32 °F to +250 °F (0 °C to +121 °C)

PRESSURE RATING: 325 psi / 22.4 bar maximum

PRESSURE DROP: See Differential Pressure Chart, page 74

ACCURACY: $\pm 5\%$ of full scale

REPEATABILITY: $\pm 1\%$

DIMENSIONS: See Ordering Information Table, page 76



EZ-View with Radel® R body

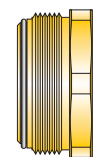
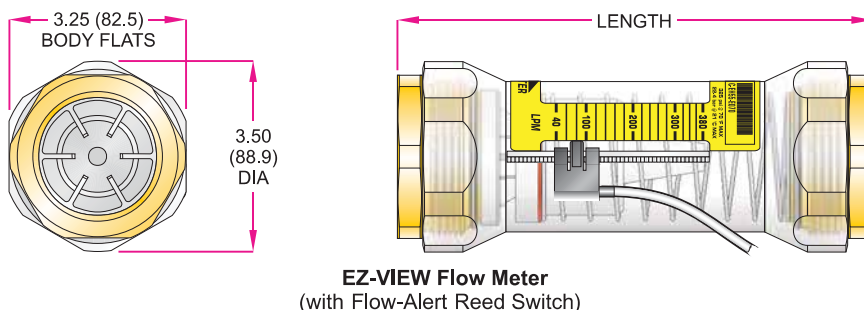
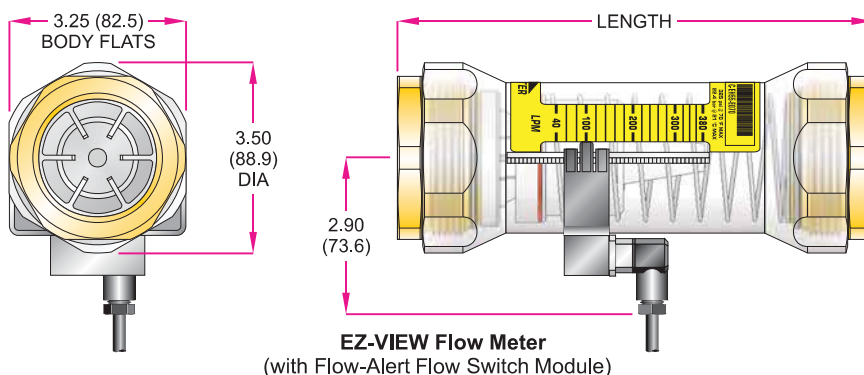

1 1/2" NPTF female brass fitting

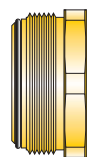

1 1/2" BSPP female brass fitting

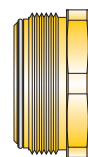

2" NPTF female brass fitting

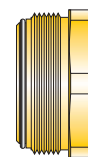

2" BSPP female brass fitting

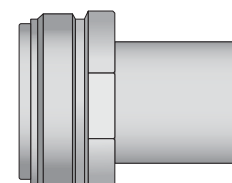

2" PVC socket weld fitting ①

① Meters with Type 1 PVC fittings:

Pressure rating per normal PVC system specifications
 Temperature range +32 °F to +140 °F (0 °C to +60 °C)

Radel is a registered trademark of Union Carbide Corporation.

EZ-View® Flow Meters

With Flow-Alert Flow Switch

Flow Switch Options and Specifications:

The AC and DC powered Flow-Alert Flow Switch modules consist of a latching relay circuit housed in a sealed polypropylene enclosure. The modules have a normally open dry relay contact that can be used to directly control alarms, warning lights, relays or be used to interface to a PLC. The relay will be latched on as the magnet inside the flow meter passes by the module, and remain latched on until the magnet passes in the other direction or power is interrupted. The set point is adjustable from 0 to 100% of full scale.

The Reed Switch Flow-Alert modules are housed in a sealed polypropylene enclosure. The reed switch module does not provide the latching function like the AC and DC powered units. When the magnet inside the flow meter comes within proximity of the module, the reed switch will change state. The set point is adjustable from 0 to 100% full scale. Two reed switches providing low flow and high flow set points may be installed on a single flow meter.

	AC Latching	DC Latching	Reed Switch Form-A Normally Open (NO)	Reed Switch Form-B Normally Closed (NC)	Reed Switch Form-C
Operating Voltage	115 VAC ±10%	10-30 VDC	–	–	–
Operating Current	25 mA maximum	25 mA maximum	–	–	–
Contact Rating	1A @ 30 VDC 0.5A @ 125 VAC Resistive Load	1A @ 30 VDC 0.5A @ 125 VAC Resistive Load	1A max 200 VDC max 15 Watts max Resistive Load	0.25A max 175 VDC max 5 Watts max Resistive Load	0.25A max 175 VDC max 5 Watts max Resistive Load
Operating Temperature	+32 to +158 °F (0 to +70 °C)	+32 to +158 °F (0 to +70 °C)	+32 to +250 °F (0 to +121 °C)	+32 to +250 °F (0 to +121 °C)	+32 to +250 °F (0 to +121 °C)
Connector	4-pin connector (Protection Class IP65)	4-pin connector (Protection Class IP65)	–	–	–
Cable	Not Included	Not Included	3 foot, 2-wire #24 AWG black PVC Jacketed pig-tail	3 foot, 2-wire #20 AWG grey PVC Jacketed pig-tail	3 foot, 3-wire #24 AWG grey PVC Jacketed pig-tail
Rating	NEMA 12 & 13 (IP65)	NEMA 12 & 13 (IP65)	NEMA 12 & 13 (IP65)	NEMA 12 & 13 (IP65)	NEMA 12 & 13 (IP65)
Certification	N/A	EMC Directive 89/336/EEC	EMC Directive 89/336/EEC	EMC Directive 89/336/EEC	EMC Directive 89/336/EEC
Model Number	H526-004	H526-006	H526-008-NO	H526-008-NC	H526-008

NOTE: Flow switches and flow meters sold separately

Ordering Information

Fluid Media	Flow Range		1½" NPTF female, brass fitting	1½" BSPP female, brass fitting	2" NPTF female, brass fitting	2" BSPP female, brass fitting	2" PVC socket weld fitting ^①
	GPM	LPM					
Oil 0.876 s.g.	2 – 25	10 – 95	H615-725-R	H616-725-R	H617-725-R	H618-725-R	
	5 – 50	20 – 190	H615-750-R	H616-750-R	H617-750-R	H618-750-R	
	7 – 75	30 – 280	H615-775-R	H616-775-R	H617-775-R	H618-775-R	
	10 – 100	40 – 380	H615-710-R	H616-710-R	H617-710-R	H618-710-R	
Water 1.0 s.g.	2 – 25	10 – 95	H615-625-R	H616-625-R	H617-625-R	H618-625-R	H619-625-R
	5 – 50	20 – 190	H615-650-R	H616-650-R	H617-650-R	H618-650-R	H619-650-R
	7 – 75	30 – 280	H615-675-R	H616-675-R	H617-675-R	H618-675-R	H619-675-R
	10 – 100	40 – 380	H615-610-R	H616-610-R	H617-610-R	H618-610-R	H619-610-R
DIMENSIONS:	Length ^② in (mm)		8.72 (221.5)	8.72 (221.5)	8.72 (221.5)	8.72 (221.5)	11.48 (291.6)
	Fitting Flats in (mm)		3.00 (76.2)	3.00 (76.2)	3.00 (76.2)	3.00 (76.2)	N/A
	Weight lb (kg)		4.10 (1.86)	4.10 (1.86)	3.10 (1.41)	3.10 (1.41)	1.70 (0.77)

^① Fits 2" Sch 40/80 PVC, CPVC pipe.

^② Length includes end fitting.

NOTE: Flow switches and flow meters sold separately

EZ-View® Flow Meters

In-Line Test Kits

- Simultaneously monitors in-line flow & pressure
- Compact & self-contained
- Mounts in any position
- Easily carried in tool kit

Here is a convenient, low-cost diagnostic tool to help you check flow and pressure simultaneously. The EZ-View in-line test kits were designed to measure flow from 0.5 to 28 GPM (2 to 106 LPM), and operating pressures up to 160 psi (11 bar).

This compact, self-contained unit is easy to install, and can be used as a permanent monitoring indicator, or as a temporary troubleshooting tool to help: **check pump leakage under load, verify proper flow, pressure or control settings, locate line restrictions, verify pressure drops and balance multi-line systems.**



EZ-View with Polysulfone body



EZ-View with Radel® R body

SPECIFICATIONS:

MATERIALS:

Polysulfone plastic body, piston and cone

Radel® R plastic body and cone, polysulfone piston

COMMON PARTS:

Spring: T300-series stainless

Indicator Ring: Buna N

Pressure Seals: Buna N

Fittings: C360 brass, PVC, or T303 stainless steel

Limit Indicators: Polypropylene

Retaining Ring: PH15 – 7MO stainless

OPTIONAL (consult factory):

Spring and Retaining Ring: Teflon® coated

Load Valve:

Polyvinyl Chloride (PVC) - 1 body

Polypropylene Ball

Teflon® Ball Seat

Ethylene Propylene (EPDM) O-ring

FITTINGS/ THREADS:

Flow Meter: NPT – 1 inch male / ANSI/ASME B1.20.1

Load Valve: NPT – 1 inch female / ANSI/ASME B1.20.1

TEMPERATURE RANGE: +32 °F to +150 °F (0 °C to +65.6 °C)

PRESSURE RATING: 325 psi / 22.4 bar maximum

PRESSURE GAUGE:

0 to 160 psi (0 to 11.0 bar) with internal shock dampeners and blowout patch

PRESSURE DROP: See Differential Pressure Chart, page 70

ACCURACY: ±5% of full scale

REPEATABILITY: ±1%

DIMENSIONS:

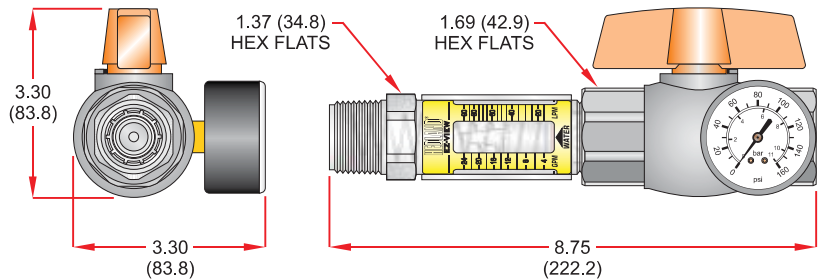

Ordering Information

Fluid Media	Flow Range		1" NPTF male/female fitting	
	GPM	LPM	Polysulfone	Radel® R
Oil 0.876 s.g.	0.50 - 4.00	2.00 - 15.0	H623-104	H623-104-R
	1.00 - 7.00	4.00 - 26.0	H623-107	H623-107-R
	1.00 - 10.0	4.00 - 35.0	H623-110	H623-110-R
	1.00 - 16.0	5.00 - 60.0	H623-116	H623-116-R
	3.00 - 18.0	15.0 - 65.0	H623-118	H623-118-R
	4.00 - 28.0	20.0 - 100	H623-128	H623-128-R
Water 1.0 s.g.	0.50 - 4.00	2.00 - 15.0	H623-004	H623-004-R
	1.00 - 7.00	4.00 - 26.0	H623-007	H623-007-R
	1.00 - 10.0	4.00 - 35.0	H623-010	H623-010-R
	1.00 - 16.0	5.00 - 60.0	H623-016	H623-016-R
	3.00 - 18.0	15.0 - 65.0	H623-018	H623-018-R
	4.00 - 28.0	20.0 - 100	H623-028	H623-028-R
Weight lb (kg)			0.80 (0.36)	

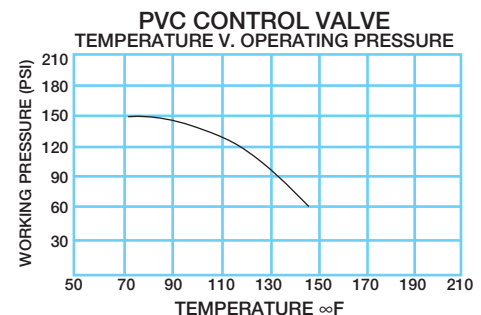

Teflon is a registered trademark of E.I. DuPont de Nemours & Co. Radel is a registered trademark of Union Carbide Corporation.

Dimensional Information

For standard 1½ inch C62, 3 inch; SAE, NPTF, BSPP and 3 inch C61

1½ inch; C62 Flange - Inches (mm)

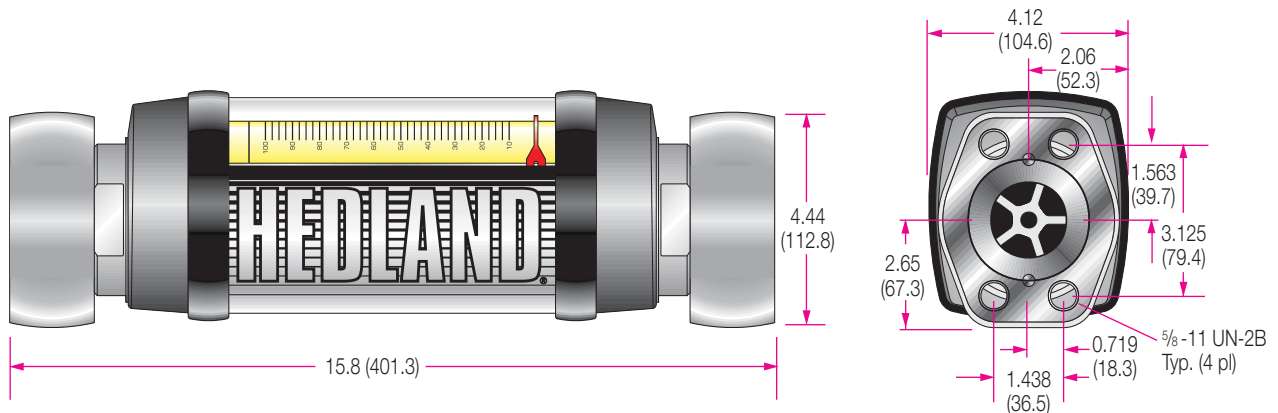

3 inch; NPTF, BSPP - Inches (mm)

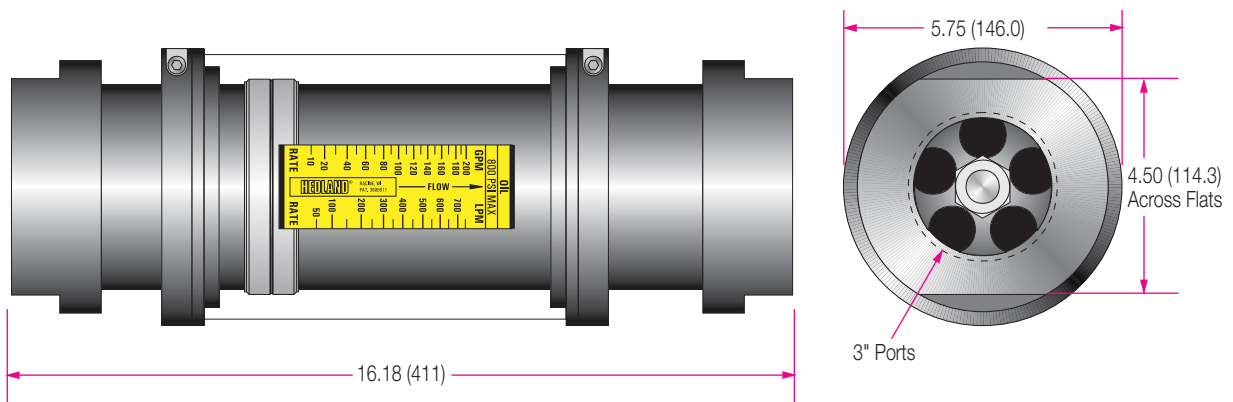

3 inch; C61 Flange - Inches (mm)

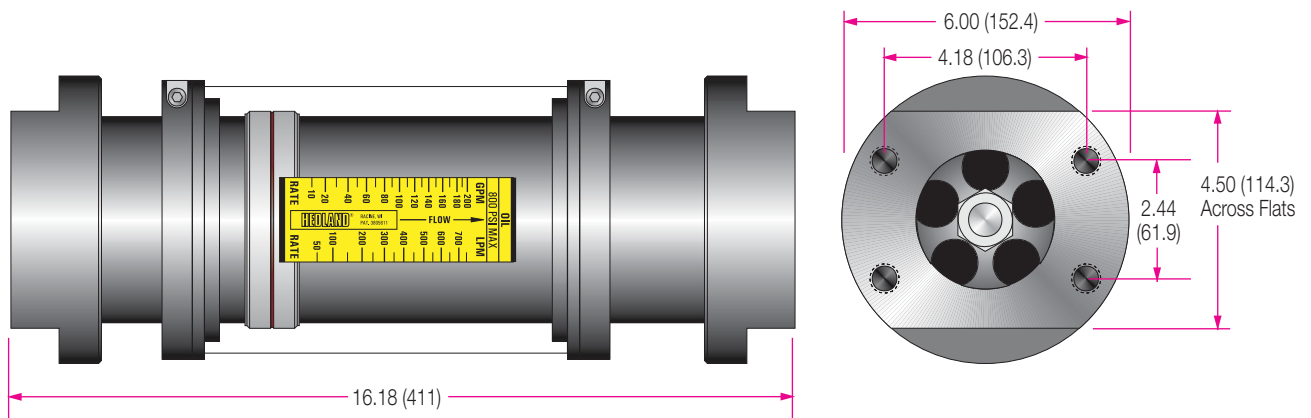

SIZE	WEIGHTS For all Flow Meter Models	ALUMINUM w/Aluminum Internals	BRASS w/Brass Internals	T303 SS w/Aluminum Internals	T303 SS w/Brass Internals	T316 SS w/T316 SS Internals	HOSTILE ENVIRONMENT T316 SS w/T316 Internals
		lbs. (kg)	lbs. (kg)	lbs. (kg)	lbs. (kg)	lbs. (kg)	lbs. (kg)
¼" (NPT & BSP) SAE 6	¼ Standard Meter	.55 (.25)	1.05 (.48)	.9 (.41)	1.05 (.48)	~	~
	¼ High Temperature	1.35 (.61)	2.75 (1.25)	CF	2.75 (1.25)	2.75 (1.25)	~
	¼ API Oil/Caustic & Corrosive Liquids & Gases	~	~	~	~	3.00 (1.36)	3.00 (1.36)
	¼ Pneumatic Meter with Extended Cap	.7 (.32)	1.6 (.73)	1.5 (.68)	~	~	~
	¼ Pneumatic Meter w/ Extended Cap w/Gauge	1.2 (.55)	2.1 (1.0)	2.0 (.91)	~	~	~
	Test Kit w/Ext. Cap/Gauge/Valve	1.6 (.73)	2.5 (1.2)	2.3 (1.1)	~	~	~
	¼ Flow-Alert Flow Switch	4.30 (1.95)	5.65 (2.56)	5.15 (2.34)	5.50 (2.50)	5.80 (2.63)	~
	¼ Flow Transmitter	4.25 (1.93)	5.60 (2.54)	5.10 (2.31)	5.45 (2.47)	5.75 (2.61)	~
½" (NPT & BSP) SAE 10	½ Standard Meter	1.25 (.57)	2.60 (1.18)	2.1 (.95)	2.45 (1.11)	~	~
	½ Liquid Test Kit	4.9 (2.2)	5.7 (2.6)	5.3 (2.4)	~	~	~
	½ High Temperature	1.35 (.61)	2.75 (1.25)	CF	2.75 (1.25)	2.75 (1.25)	~
	½ API Oil/Caustic & Corrosive Liquids & Gases	3.0 (1.4)	~	~	~	2.95 (1.34)	2.95 (1.34)
	½ Pneumatic Meter with Extended Cap	2.1 (1.0)	3.8 (1.7)	3.3 (1.5)	~	~	~
	½ Pneumatic Meter w/Extended Cap w/Gauge	2.7 (1.2)	4.3 (2.0)	3.8 (1.7)	~	~	~
	Test Kit w/Ext. Cap/Gauge/Valve	3.2 (1.5)	4.8 (2.2)	4.3 (2.0)	~	~	~
	½ Flow-Alert Flow Switch	4.30 (1.95)	5.65 (2.56)	5.15 (2.34)	5.50 (2.50)	5.80 (2.63)	~
¾" (NPT & BSP) SAE 12	¾ Standard Meter	2.0 (.9)	4.0 (1.8)	3.5 (1.6)	3.9 (1.8)	~	~
	¾ Liquid Test Kit	7.0 (3.2)	9.0 (4.1)	8.5 (3.9)	~	~	~
	¾ High Temperature	2.1 (1.0)	4.40 (2.00)	4.00 (1.81)	4.40 (2.00)	4.40 (2.00)	~
	¾ API Oil/Caustic & Corrosive Liquids & Gases	~	~	~	~	4.40 (2.00)	4.6 (2.1)
	¾ Pneumatic Meter with Extended Cap	3.0 (1.4)	6.6 (3.0)	6.2 (2.8)	~	~	~
	¾ Pneumatic Meter w/Extended Cap w/Gauge	3.5 (1.6)	7.1 (3.2)	6.7 (3.1)	~	~	~
	Test Kit w/Ext. Cap/Gauge/Valve	4.4 (2.0)	7.9 (3.6)	7.5 (3.4)	~	~	~
	¾ Flow-Alert Flow Switch	4.95 (2.25)	6.95 (3.15)	6.60 (3.00)	6.85 (3.11)	7.35 (3.33)	~
1" (NPT & BSP) SAE 16	1 Standard Meter	1.85 (.84)	3.75 (1.70)	2.7 (1.3)	3.4 (1.5)	~	~
	1 Liquid Test Kit	6.8 (3.1)	8.7 (4.0)	7.7 (3.5)	~	~	~
	1 High Temperature	3.0 (1.4)	4.40 (2.00)	4.00 (1.81)	4.40 (2.00)	4.40 (2.00)	~
	1 API Oil/Caustic & Corrosive Liquids & Gases	~	~	~	~	4.40 (2.00)	4.60 (2.10)
	1 Pneumatic Meter with Extended Cap	2.8 (1.3)	6.3 (2.9)	5.4 (2.5)	~	~	~
	1 Pneumatic Meter w/Extended Cap w/Gauge	3.3 (1.5)	6.8 (3.1)	5.9 (2.7)	~	~	~
	Test Kit w/Ext. Cap/Gauge/Valve	4.2 (1.9)	7.6 (3.5)	6.7 (3.1)	~	~	~
	1 Flow-Alert Flow Switch	4.95 (2.25)	6.85 (3.11)	5.80 (2.63)	6.50 (2.95)	7.50 (3.40)	~
1¼" (NPT & BSP) SAE 20	1¼ Standard Meter	7.3 (3.3)	16.8 (7.6)	14.6 (6.6)	16.8 (7.6)	~	~
	1¼ Liquid Test Kit	20 (9.07)	~	30 (13.6)	~	~	~
	1¼ High Temperature	9.6 (4.4)	21.40 (9.71)	CF	21.40 (9.71)	21.40 (9.71)	~
	1¼ API Oil/Caustic & Corrosive Liquids & Gases	~	~	~	~	21.40 (9.71)	CF
	1¼ Pneumatic Meter with Extended Cap	9.9 (4.5)	24.3 (11.0)	21.1 (9.6)	~	~	~
	1¼ Pneumatic Meter w/Ext. Cap w/Gauge	10.4 (4.7)	24.8 (11.2)	21.7 (9.8)	~	~	~
	Test Kit w/Ext. Cap/Gauge/Valve	12.5 (5.7)	27.0 (12.3)	23.8 (10.8)	~	~	~
	1¼ Flow-Alert Flow Switch	13.55 (6.15)	23.05 (10.46)	20.85 (9.46)	23.05 (10.46)	27.65 (12.54)	~
1½" (NPT & BSP) SAE 24	1½ Standard Meter	7.3 (3.3)	16.4 (7.5)	14.1 (6.4)	15.8 (7.2)	~	~
	1½ Standard Meter w/C62 Flange	19.0 (8.6)	28.2 (12.8)	25.8 (11.7)	~	~	~
	1½ Liquid Test Kit	20 (9.07)	~	30 (13.6)	~	~	~
	1½ High Temperature	9.6 (4.4)	21.40 (9.71)	CF	21.40 (9.71)	21.40 (9.71)	~
	1½ High Temperature w/C62 Flange	CF	21.8 (9.9)	CF	CF	CF	~
	1½ API Oil/Caustic & Corrosive Liquids & Gases	~	~	~	~	21.40 (9.71)	CF
	1½ Pneumatic Meter with Extended Cap	9.9 (4.5)	23.9 (10.8)	20.6 (9.4)	~	~	~
	1½ Pneumatic Meter w/Extended Cap w/Gauge	10.4 (4.7)	24.4 (11.1)	21.2 (9.6)	~	~	~
	Test Kit w/Ext. Cap/Gauge/Valve	12.5 (5.7)	26.6 (12.1)	23.3 (10.6)	~	~	~
	1½ Flow-Alert Flow Switch	13.55 (6.15)	22.65 (10.27)	20.35 (9.23)	22.05 (10.00)	27.65 (12.54)	~
3"	3 Standard Meter	17.5 (8.0)	52.5 (23.8)	~	~	~	~
	3 Standard Meter w/C61 Flange	20.0 (9.1)	55.0 (25.0)	~	~	~	~

~: Not available as standard option

CF: Consult factory for weights

BADGER METER, INC. (“BADGER METER”) GENERAL SALES INFORMATION

Purchase Orders

Minimum order size is \$50.00 plus freight charges. Blanket orders and special product orders are subject to extraordinary charges for delivery schedule changes and/or cancellations.

Transportation Terms

Pricing and shipments are FCA the Badger Meter factory. Badger Meter assumes no liability for damaged or lost shipment. Claims must be made by the customer to the freight carrier. Product title transfers to the customer at the factory dock. Prices and specifications are subject to change without notice.

Payment Terms

Net 30 days of invoice date to companies with approved line of credit. For new accounts, please allow two weeks for credit approval. Badger Meter accepts American Express, MasterCard, Visa, and Cash. Accounts with balances exceeding 30 days are subject to cash on delivery (C.O.D.) status. All orders are subject to written acceptance by Badger Meter. Buyer's terms and conditions are not accepted unless approved by an authorized officer of Badger Meter.

Delivery Dates

Delivery dates are estimates only and may be subject to delays due to influences beyond the control of Badger Meter.

Export

Terms, discounts, special packing and conditions of sale for purchase orders originating from or for shipment to final destination outside the fifty states of the USA and Canada will be furnished upon request. Payment shall be made in United States currency. Shipments are Ex Works the Badger Meter factory (e.g. the buyer is responsible for the cost of freight, cost of insurance, taxes/duties and customs fees).

Customer Validation

Badger Meter reserves the right to determine OEM qualifications of any and all buyers or to request end customer invoicing in situations where project pricing may have been granted by the factory. For complete and governing purchase terms, visit <http://www.badgermeter.com/Company/Legal/Purchase-Terms.htm>.

BADGER METER RETURNED GOODS POLICY

Any product to be returned to Badger Meter for credit, warranty or servicing must have a Returned Material Authorization (RMA) logged into the Badger Meter Return Material System within the previous 90 days. Any return without an RMA will not be accepted. Please note that all returns are conditional, pending inspection by Badger Meter.

Requesting an RMA

The following information will be required to process an RMA: a reason for return and the invoice number of purchased item to be returned. Please contact Badger Meter Customer Service to initiate the RMA and assign a number to the return.

Returned Goods Labeling

The RMA number must be visible on the returned material packaging. The RMA number must be clearly labeled on the outside of the carton. Returned goods without an RMA will be refused by the receiving department at Badger Meter.

Inbound Freight

Upon issuance of an RMA all goods shall be shipped prepaid to Badger Meter. The customer is responsible for freight for returns unless otherwise agreed to in writing in advance. If Badger Meter agrees to pay for freight at the time the RMA is logged in, the Customer Service Representative will e-mail or fax the customer a list of Badger Meter Approved Carriers and Freight Policy.

Badger Meter shall not be responsible for damage caused by inadequate return packaging or shipping. Please package returned products in their original packaging or equivalent to ensure that they will arrive undamaged.

Warranty Returns

Any warranty returns may be repaired or replaced at the discretion of Badger Meter. See the governing warranty statement at www.badgermeter.com. Warranty repairs will be returned to the customer at no charge via ground freight only. If you require overnight or other special arrangements, this will be available at the customer's expense.

Service/Calibration Returns

Before a customer returns any product for service/calibration, and before Badger Meter begins any work, the customer must deliver a written purchase order to Badger Meter, including acceptance of Badger Meter payment terms and pricing. The customer is responsible for both inbound and outbound freight.

Warranty and Service Return Special Instructions

Before shipping your equipment, please be sure to remove any customer-supplied items such as end fittings, enclosures, wiring, etc. Shipping these items with your equipment increases the cost of both inbound and outbound freight and serves no purpose. Badger Meter will not "reassemble" non-Badger Meter parts and is not responsible for loss of any accessories not needed in testing and/or repair. Products must be thoroughly cleaned and any process chemicals removed before sending for service/calibration. Non-compliant returned goods will be returned to the customer untouched at the customer's cost.

Returns for Credit

All returns are at the sole discretion of Badger Meter. All returns for credit are subject to a 25% restocking charge. If an offsetting order is placed, and the offsetting value is equal to or greater than the value of the returned goods, then the restocking charge is 15%. No credit will be allowed unless the returned items are currently in production, and are in new and re-saleable condition, at the sole discretion of Badger Meter. Any returned goods beyond 90 days from the date of invoice, any special/custom (e.g. non-standard) configurations, any slow-moving products, or any private-labeled products are subject to refusal of a return for credit at the sole discretion of Badger Meter. In these situations if a return for credit is authorized, a restocking charge greater than 25% may be imposed.

INTENTIONAL BLANK PAGE



Control. Manage. Optimize.

Trademarks appearing in this document are the property of their respective entities.

Due to continuous research, product improvements and enhancements, Badger Meter reserves the right to change product or system specifications without notice, except to the extent an outstanding contractual obligation exists. © 2016 Badger Meter, Inc. All rights reserved.

racorders@badgermeter.com | www.badgermeter.com

Phone: 877-243-1010 | Fax: 800-245-3569

The Americas | Badger Meter | 4545 West Brown Deer Rd | PO Box 245036 | Milwaukee, WI 53224-9536 | 800-876-3837 | 414-355-0400
México | Badger Meter de las Americas, S.A. de C.V. | Pedro Luis Ogazón N°32 | Esq. Angelina N°24 | Colonia Guadalupe Inn | CP 01050 | México, DF | México | +52-55-5662-0882
Europe, Middle East and Africa | Badger Meter Europa GmbH | Nurtinger Str 76 | 72639 Neuffen | Germany | +49-7025-9208-0
Europe, Middle East Branch Office | Badger Meter Europe | PO Box 341442 | Dubai Silicon Oasis, Head Quarter Building, Wing C, Office #C209 | Dubai / UAE | +971-4-371 2503
Czech Republic | Badger Meter Czech Republic s.r.o. | Mařikova 2082/26 | 621 00 Brno, Czech Republic | +420-5-41420411
Slovakia | Badger Meter Slovakia s.r.o. | Racianska 109/B | 831 02 Bratislava, Slovakia | +421-2-44 63 83 01
Asia Pacific | Badger Meter | 80 Marine Parade Rd | 21-06 Parkway Parade | Singapore 449269 | +65-63464836
China | Badger Meter | 7-1202 | 99 Hangzhong Road | Minhang District | Shanghai | China 201101 | +86-21-5763 5412
Switzerland | Badger Meter Swiss AG | Mittelholzerstrasse 8 | 3006 Bern | Switzerland | +41-31-932 01 11